

GRIVAL

LA PREFERIDA POR LOS
EXPERTOS

PRODUCTOS
COMPATIBLES CON



CATÁLOGO DE **PRODUCTOS**

CONTENIDO

CATÁLOGO DE PRODUCTOS

GRIVAL ofrece a los expertos la más completa solución de conexión y conducción de agua y gas, así como un amplio y organizado portafolio de repuestos para griferías y complementos con todo el respaldo, garantía y servicio postventa.

SOLUCIONES GRIVAL

BAÑOS MODERNOS	10
BAÑOS TRADICIONALES	12
SANITARIO	14
COCINAS	16
LAVADERO	18
EL HOGAR	20

SIFONES, DESAGÜES Y CANASTILLAS 20

KIT SIFONES Y DESAGÜES	22
SIFONES	24
DESAGÜES	26
CANASTILLAS	28

REGULACIONES Y ACOPLES 29

KIT REGULACIONES + ACOPLES	30
REGULACIONES	32
ACOPLES	34

LLAVES TERMINALES 39

LLAVE COCINA	40
LLAVES DE JARDÍN	40

VÁLVULAS DE CONTROL 42

KIT VÁLVULAS	44
VÁLVULAS TANQUE RESERVA	45
VÁLVULAS DE BOLA METÁLICAS	46
VÁLVULAS DE BOLA PVC	49
VÁLVULAS DE CHEQUE	50

CONTROLADORES DE PRESIÓN 51

BOMBA PRESURIZADORA G4	52
BOMBA PRESURIZADORA G3	52
BOMBA PRESURIZADORA G2	54
BOMBA PRESURIZADORA G1	53

REJILLAS 55

REJILLAS PISO	56
REJILLAS VENTILACIÓN	58
TAPA REGISTRO	59

MEJORAMIENTO DEL AGUA 60

FILTROS	61
CARTUCHOS	63

GRIFERÍA TANQUE 64

KIT GRIFERÍA TANQUE	65
VÁLVULAS DE LLENADO	67
VÁLVULAS DE DESCARGA	68
SELLOS LENGÜETA	71
TAPAS TANQUE SANITARIO	72
BOTONES	74
MANIJAS	75

CONTENIDO

CATÁLOGO DE PRODUCTOS

REPUESTOS GRIFERÍA	
GRIFERÍAS DE LAVAPLATOS	79
LAVAPLATOS 8 PULGADAS	80
LAVAPLATOS SENCILLO	86
LAVAPLATOS DE PARED	90
GRIFERÍAS DE LAVAMANOS	91
LAVAMANOS SENCILLO	92
GRIFERÍAS DE LAVAMANOS 4 PULGADAS	95
LAVAMANOS 4 PULGADAS	96
GRIFERÍAS DE LAVAMANOS 8 PULGADAS	99
LAVAMANOS 8 PULGADAS	100
DUCHAS	103
DUCHAS SENCILLAS	104
DUCHAS 8 PULGADAS	110
PRODUCTOS DESCONTINUADOS	115
LAVAPLATOS DESCONTINUADOS	115
LAVAMANOS DESCONTINUADOS	119
DUCHAS DESCONTINUADOS	121

REPUESTOS SANITARIOS	123
ACUACER	126
ACUAPLUS II	127
AQUAJET	127
AQUAPRO	127
AVANTI PLUS	128
SANITARIO ECOCLEAN	129
GANAMAX	129
HAPPY	130
KIDDY	130
LAGUNA	131
MANANTIAL	131
MAZARA	132
PIAMONTE	132
POWER ONE	132
SENSACIÓN	133
TREVI	134
QUADRATO PLUS	135
MANAOS	135
RECIFE	136
BAIA	136
BROADWAY	137
MONTECARLO	135
VITERBO	137
MONTECARLO ADVANCE	137
SAN GIORGIO	138
SEVILLA	139
KALAVI	139
SMART	138
SOLARE	141
FUSSION	141
PRESTIGIO 4 LITROS	141
VITERBO	141
POWERMAX	142
BURGOS	142
OPORTO	142
CASCADE	143

SANITARIOS DESCONTINUADOS	140
ACUARIO	142
CYCLONE ULTRA	142
NOVARA HET	142
PORTENTO PLUS	143
REGGIO	143
STILO	143
BARI	144
CAPRI	144
CRESCENTO	144
GALES	145
EBOLI	145
NAPOLI	145
DISTINCIÓN	146
ENSO	146
POTENZA PLUS	146
TAO	147
BRONZO	148
IMOLA	148
SELECTA	148
MÁXIMO	149
DIAQUA	149
NIZA	150
SONDRIO	150
PRESTIGIO 6 LITROS	150
ECOLEAN	153
MONTECARLO	153
SMART	154
SOLARE	154
LUGO	155
BILBAO	155
KIT DE INSTALACIÓN	149
KIT 1	151
KIT 2	151
KIT 3	151
OTROS REPUESTOS	157
COMPLEMENTOS KIT BIDÉ	158

SERVICIO POST VENTA

SERVICIO TÉCNICO ESPECIALIZADO POST VENTA

Cada día **GRIVAL** quiere estar más cerca de usted, para brindarle una solución rápida y eficaz a sus necesidades en:

ATENCIÓN DE GARANTÍAS

Contamos con personal altamente calificado para emitir conceptos técnicos y brindar soluciones efectivas, con un alto grado de confiabilidad y tranquilidad.

ASESORÍA Y CAPACITACIÓN

Recibirá asesoría en sus proyectos de obra nueva o remodelación, en los requerimientos técnicos y características de nuestros productos. Contamos con capacitación para arquitectos, plomeros e instaladores.

INSTALACIÓN

Nuestros técnicos están capacitados y certificados para realizar la instalación de todos nuestros productos con una garantía, en mano de obra, de 6 meses directamente de fábrica.

MANTENIMIENTO

Ofrecemos mantenimiento preventivo, como limpieza general y cambio de los componentes que están en constante uso. Esto alarga la vida útil del producto y hace más rentable su inversión.

REPUESTOS ORIGINALES

Cada pieza es de importancia vital para el desempeño y ahorro de las griferías. **GRIVAL** cuenta con amplia gama de repuestos originales los cuales han sido desarrollados para garantizar el funcionamiento óptimo de sus productos.

SERVICIO AUTORIZADO GRIVAL

PUNTO DE SERVICIO AUTORIZADO GRIVAL

CIUDAD	DIRECCIÓN	TELÉFONO
BOGOTÁ	AV. CARACAS # 63 - 63 / CHAPINERO	3 481 746
BOGOTÁ NORTE	AV. CARRERA 45 # 149 - 09 / MAZURÉN	6 140 241
BARRANQUILLA	CALLE 84 # 43 - 49 / LOCAL 2	3 735 347
BUCARAMANGA	CRA 16 # 42 -89 / BARRIO CENTRO	6 334 754
CALI	CALLE 10 # 42 - 54	5 525 150
CARTAGENA	AV PEDRO DE HEREDIA # 21 - 83 / LOCAL 3	6 140 241
ENVIGADO - EL DORADO	CRA 41 # 39 SUR 63	3 027 993
MEDELLÍN	CRA 49 # 45 - 18 / JUNÍN CON AMADOR	5 114 086
PEREIRA	CALLE 20 # 9 - 41	3 257 269

SERVICIO AUTORIZADO GRIVAL COLOMBIA

CIUDAD	DIRECCIÓN	TELÉFONO
ARAUCA	CRA 25 # 23 - 03	8 857 671
BARRANCABERMEJA	CALLE 52 # 14 - 70 / BARRIO COLOMBIA	6 110 530
CÚCUTA	AV 11 E # 9N - 28	5 746 097
IBAGUÉ	CALLE 87 # 5 - 04 / LAS MARGARITAS - LOCAL 2	2 680 267
MANIZALES	CRA 20 # 20 - 13	8 847 549
MONTERÍA	CALLE 38 # 3 - 27 / CENTRO	7 826 065
RÍO NEGRO	KILÓMETRO 3 VÍA LLANO GRANDE	5 372 811
SAN ANDRÉS ISLA	AV 20 DE JULIO / EDIFICIO FED	5 123 915
TUNJA	CALLE 19 # 14 - 21 / CENTRO	7 440 385
TULUÁ	CALLE 28 # 23 - 52	2 247 989
VILLAVICENCIO	AV. 40 # 27 - 77 / BARRIO 7 DE AGOSTO	6 680 555

LÍNEAS DE ATENCIÓN GRATUITA INTERNACIONAL

COLOMBIA	01 8000 512 030
COSTA RICA	08000 121 672
ECUADOR	1 800 001 065
MÉXICO	0018 669 705 030
PERÚ	0 800 54 124

NORMATIVIDAD

Nuestros productos cumplen con los más altos estándares de calidad en las siguientes normas:

IAPMO IGC 157 20067

International Association of Plumbing and Mechanical Officials

IAPMO guide criteria for ball valves.

NORMA TÉCNICA COLOMBIANA NTC 1644

Accesorios de suministro en fontanería.

NORMA TÉCNICA COLOMBIANA NTC 1762

Válvulas tipo globo, de compuerta y de retención de aleaciones de cobre.

NORMA TÉCNICA COLOMBIANA NTC 3740

Válvulas metálicas para gas, accionadas manualmente para uso en sistemas de tuberías con presiones manométricas de servicio, inferiores a 0,069 bar (1 psi).

NORMA TÉCNICA COLOMBIANA NTC 3538

Aparatos mecánicos.

Válvulas metálicas para gas accionadas manualmente para uso en sistemas de tubería con presiones manométricas de servicio desde 6,8 kpa (1 psi) hasta 861 kpa (125 psi). Tamaños desde 6,35 mm (1/4 de pulgada) hasta 50,8 mm (2 pulgadas).

NORMA TÉCNICA COLOMBIANA NTC 5302

Accesorios de desagüe en fontanería.

NORMA TÉCNICA COLOMBIANA NTC 5339

Accesorios para baños.

NORMA TÉCNICA COLOMBIANA NTC 5441

Conectores flexibles para agua.

NORMA TÉCNICA COLOMBIANA NTC 1500

Código colombiano de instalaciones hidráulicas y sanitarias.

NORMA TÉCNICA COLOMBIANA NTC 3628

Válvulas de llenado antisifón para tanques de inodoros.

NORMA TÉCNICA COLOMBIANA NTC 920

Aparatos sanitarios de cerámica.

NORMA TÉCNICA COLOMBIANA NTC 4846

Asientos sanitarios plásticos.

CERTIFICADO DE CONFORMIDAD DE PRODUCTO # 466

Evaluado conforme a los requisitos de: Resolución No 90708 del 30 de Agosto de 2013 Reglamento Técnico de instalaciones eléctricas RETIE, numerales 20 y 20, 21.



Certificado N° CS-LCO-13637-2021/235
Resolución N° 90708

SOLUCIONES GRIVAL PARA BAÑOS MODERNOS

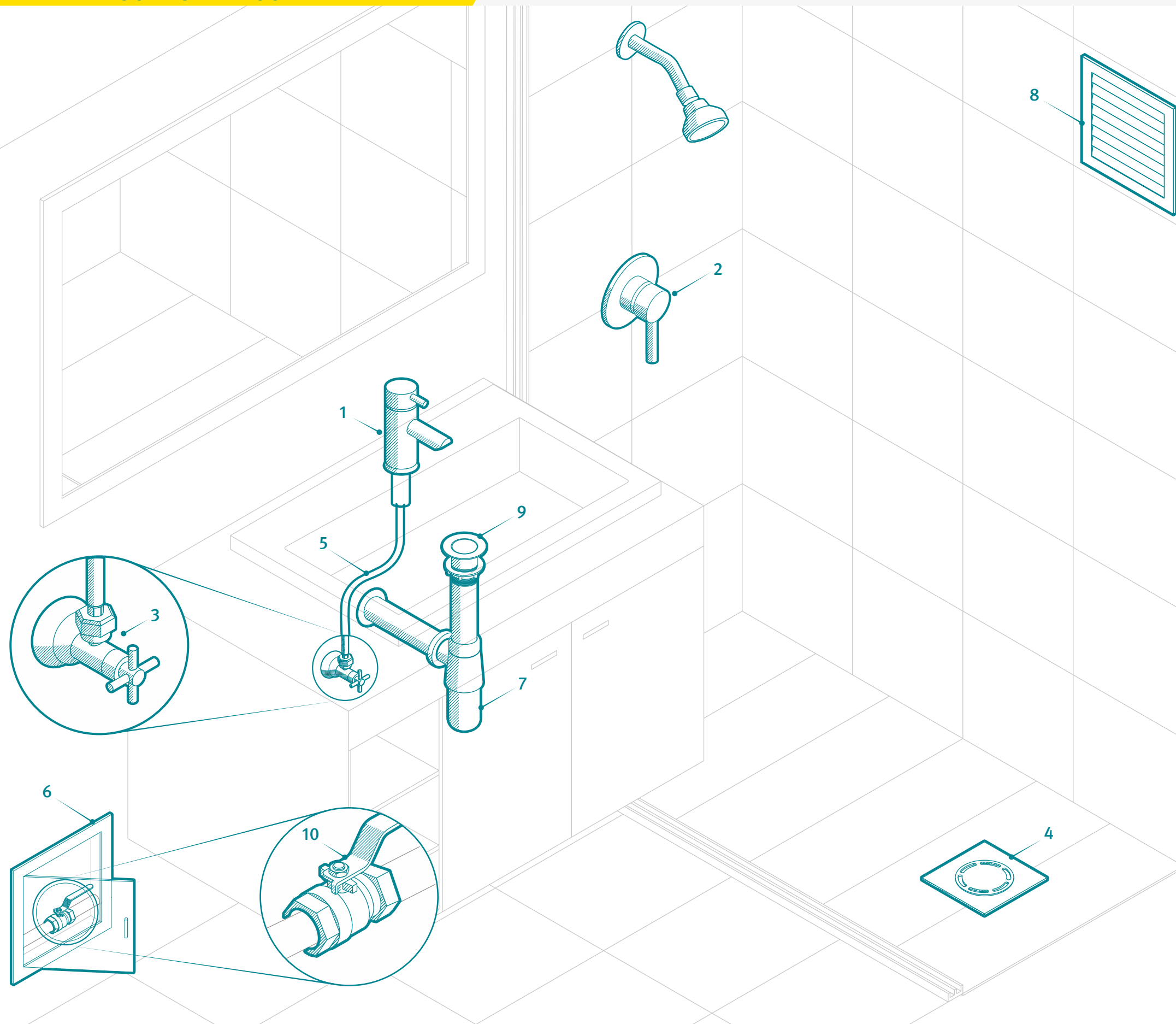

SE RECOMIENDA INSTALAR CON:

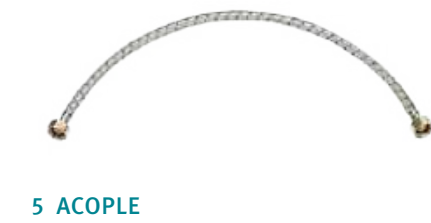

SOLUCIONES GRIVAL PARA BAÑOS TRADICIONALES



SE RECOMIENDA INSTALAR CON:



1 LLAVE 4P
NOGAL



2 DUCHA
NOGAL 8P



3 REGULACIÓN



4 REJILLA DE PISO
METÁLICA



5 ACOPLÉ



6 TAPA
REGISTRO



7 SIFÓN



8 REJILLA DE
VENTILACIÓN

9 DESAGÜE



10 VÁLVULA
DE CONTROL

SOLUCIONES GRIVAL PARA SANITARIO

SE RECOMIENDA INSTALAR CON:



1 REGULACIÓN



2 VÁLVULA DE CONTROL



3 BRIDA SANITARIA



4 TAPA REGISTRO



5 ACOPLE METÁLICO Y PLÁSTICO PARA SANITARIO



6 REJILLA DE VENTILACIÓN



7 KIT BIDE

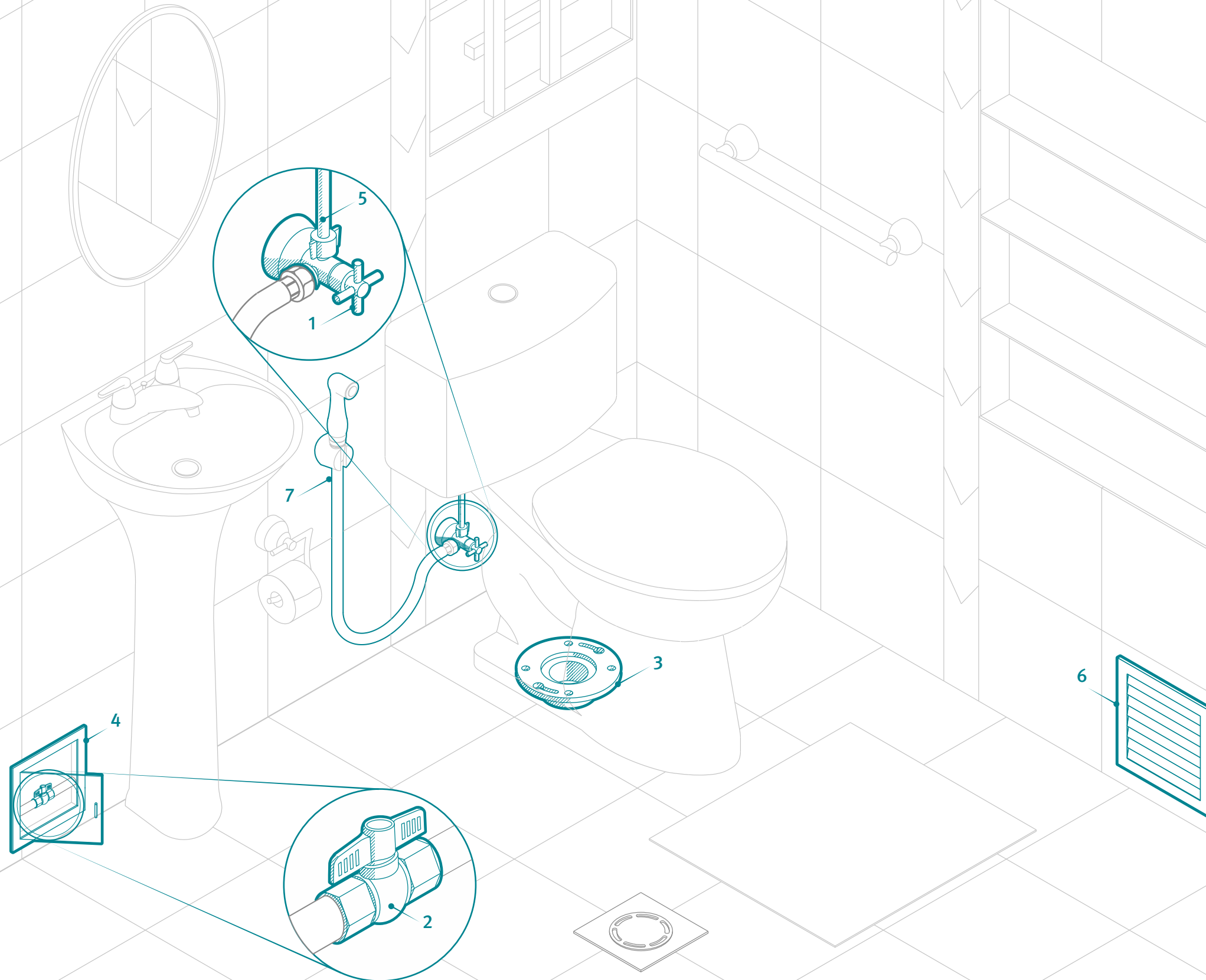
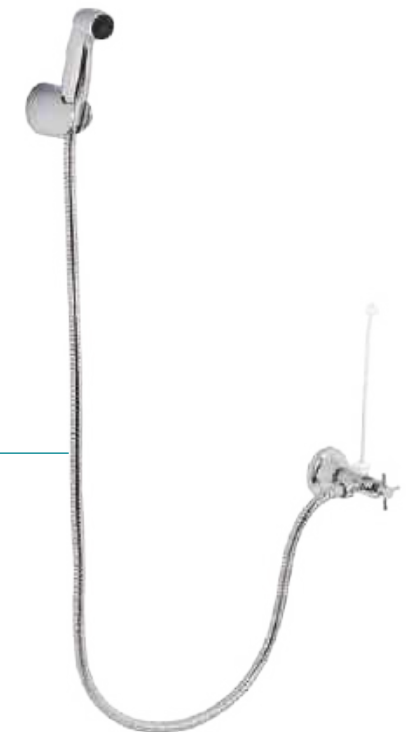

SOLUCIONES GRIVAL PARA COCINAS



SE RECOMIENDA INSTALAR CON:



1 LAVAPLATOS
VERA BASIC



2 ACOPLÉ



3 REGULACIÓN
METÁLICA



4 CANASTILLA
METÁLICA



5 SIFÓN EN P METÁLICO
PARA LAVAPLATOS



6 TAPA
REGISTRO



7 VÁLVULA
DE BOLA



8 REJILLA DE
VENTILACIÓN



9 REJILLA DE PISO
METÁLICA



10 FILTRO DE AGUA

SOLUCIONES GRIVAL PARA LAVADERO

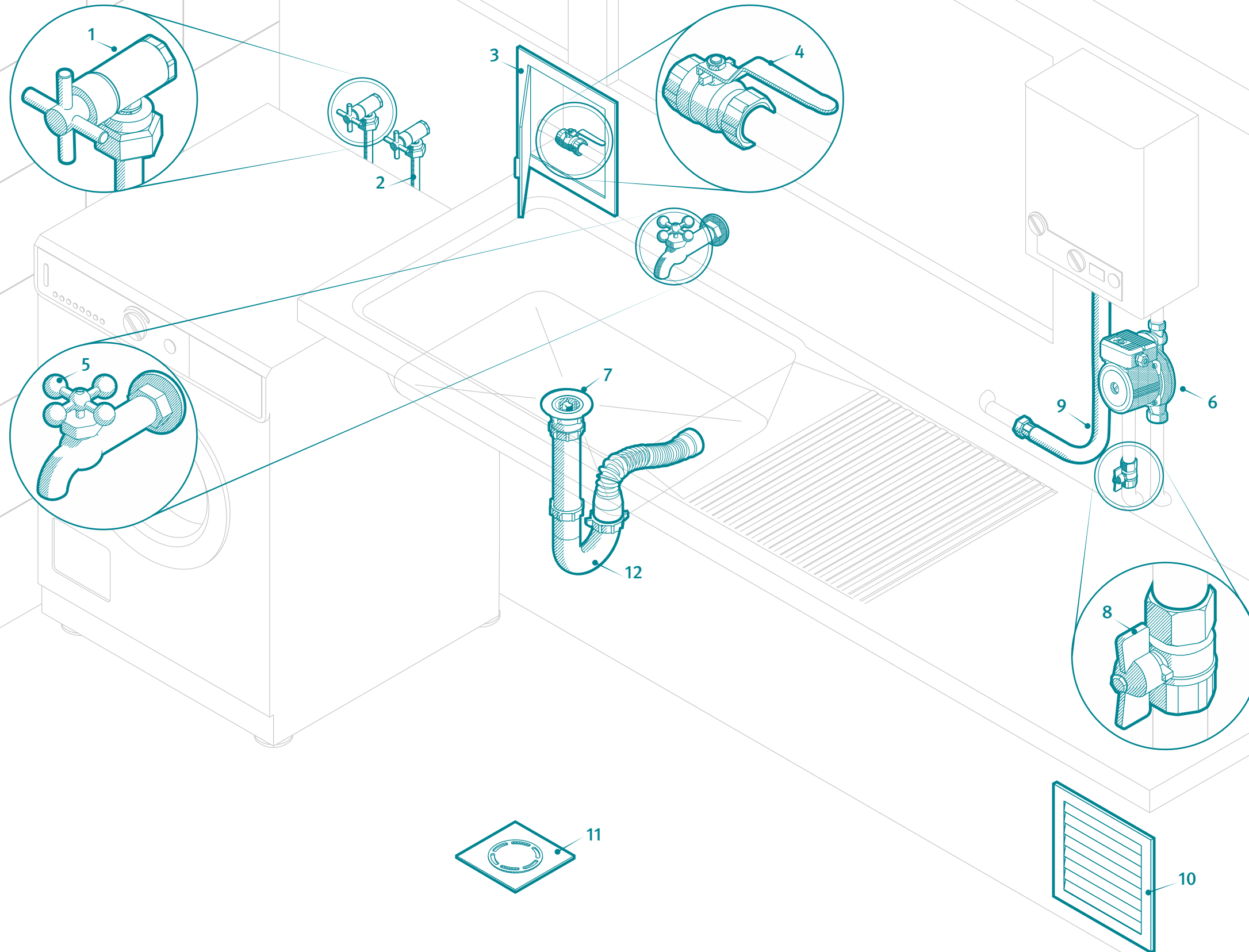

SE RECOMIENDA INSTALAR CON:



1 REGULACIÓN



2 MANGUERA LAVADORA



3 TAPA REGISTRO



4 VÁLVULA DE BOLA



5 LLAVE TERMINAL



6 BOMBA PRESURIZADORA



7 CANASTILLA 2P



8 VÁLVULA DE BOLA GAS TROCABLE



9 ACOPLÉ METÁLICO PARA CALENTADOR



10 REJILLA DE VENTILACIÓN



11 REJILLA DE PISO METÁLICA



12 SIFÓN EN P FLEXIBLE

SOLUCIONES GRIVAL PARA EL HOGAR

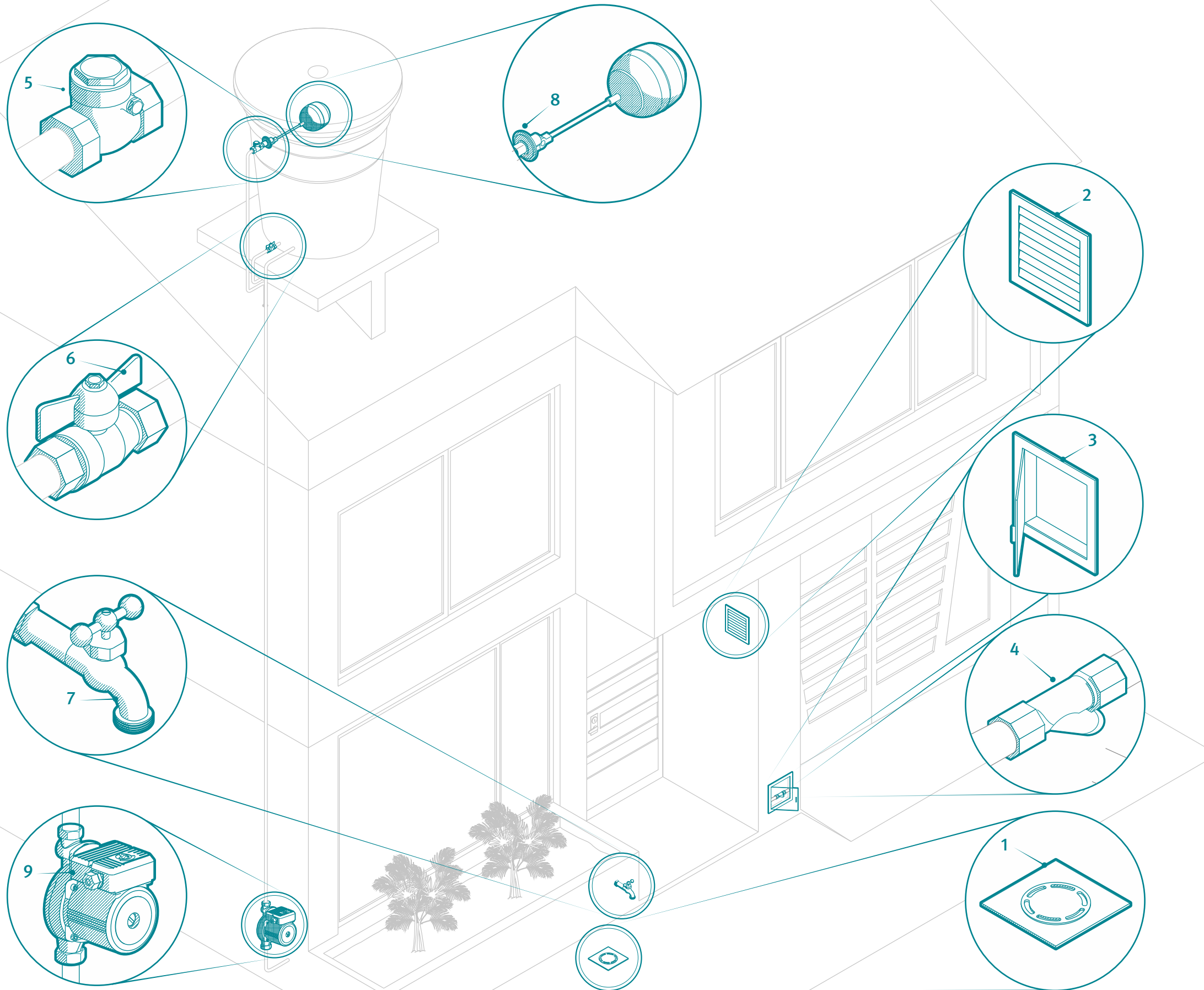

SE RECOMIENDA INSTALAR CON:



1 REJILLA DE PISO METÁLICA



2 REJILLA DE VENTILACIÓN



3 TAPA REGISTRO



4 FILTRO EN Y



5 CHEQUE CORTINA



6 VÁLVULA DE BOLA + CHEQUE



7 LLAVE TERMINAL



8 VÁLVULA TANQUE ABASTO METÁLICA



9 PRESURIZADOR

SIFONES, DESAGÜES Y CANASTILLAS

BENEFICIOS Y RECOMENDACIONES

- Diferentes acabados que complementan los ambientes de baño y cocina.
- Productos plásticos y metálicos.

USOS

- Lavamanos.
- Lavaplatos.
- Lavaderos.



KIT SIFONES Y DESAGÜES



KIT CANASTILLA GRIS + SIFÓN P

REFERENCIA	PAQUETE
935130001	Und.



KIT CANASTILLA CROMADA + SIFÓN P

REFERENCIA	PAQUETE
935180001	Und.
935303331	x4



CANASTILLA + SIFÓN FLEXIBLE + 1 GRIFLEX + 1 REGULACIÓN

REFERENCIA	PAQUETE
957935551	Und.



KIT DESAGÜE SENCILLO + 2 GRIFLEX + SIFÓN

REFERENCIA	PAQUETE
931430001	Und.
931435551	Und.



KIT DESAGÜE SENCILLO + 2 GRIFLEX + SIFÓN

REFERENCIA	PAQUETE
931715551	Und.



SIFÓN AHORRA ESPACIO + DESAGÜE PUSH PLÁSTICO

REFERENCIA	PAQUETE
931685551	Und.



CANASTILLA 4 PULGADAS CROMADA + SIFÓN P + 2 GRIFLEX

REFERENCIA	PAQUETE
935120001	Und.
935125551	Und.



CANASTILLA 4 PULGADAS METÁLICA + SIFÓN P PLÁSTICO + 2 GRIFLEX

REFERENCIA	PAQUETE
935065551	Und.
945065551	Und.



KIT DESAGÜE SENCILLO + SIFÓN

REFERENCIA	PAQUETE
931540001	Und.
931363331	x6
931460001	Und.



KIT DESAGÜE PUSH PLÁSTICO + SIFÓN FLEXIBLE METALIZADO

REFERENCIA	PAQUETE
937645551	Und.
941645551	Und.



SIFÓN EN P METÁLICO

REFERENCIA	PAQUETE
719630001	Und.



SIFÓN METÁLICO CLÁSICO LAVAMANOS

REFERENCIA	PAQUETE
719515551	Und.
719565551	Und.

SIFONES



SIFÓN FLEXIBLE BOTELLA METALIZADO LAVAMANOS / LAVAPLATOS

REFERENCIA	PAQUETE
937570001	Und.
 937575551	Und.



SIFÓN FLEXIBLE BOTELLA GRIS LAVAMANOS

REFERENCIA	PAQUETE
937630001	Und.
 937633331	x6



SIFÓN BOTELLA FLEXIBLE DOBLE LAVAMANOS / LAVAPLATOS

REFERENCIA	PAQUETE
937590001	Und.
 937583331	x4



SIFÓN P LAVAMANOS / LAVAPLATOS

REFERENCIA	PAQUETE
935080001	Und.
 935293331	x6
 935085551	Und.



SIFÓN BOTELLA LAVAMANOS

REFERENCIA	PAQUETE
931340001	Und.
 931353331	x6
 931345551	Und.



DESAGÜE SIFÓN LAVAMANOS / ORINAL

REFERENCIA	PAQUETE
933000001	Und.
 933005551	Und.



SIFÓN FLEXIBLE METALIZADO LAVAMANOS / LAVAPLATOS

REFERENCIA	PAQUETE
935490001	Und.
 935495551	Und.



SIFÓN FLEXIBLE GRIS LAVAMANOS / LAVAPLATOS

REFERENCIA	PAQUETE
935470001	Und.
 935473331	x6
 935485551	Und.



SIFÓN FLEXIBLE EN P

REFERENCIA	PAQUETE
937940001	Und.



SIFÓN AHORRA ESPACIO

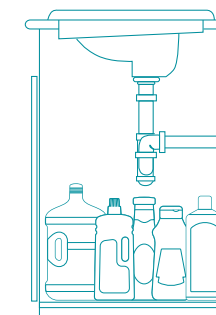

SIFÓN TRADICIONAL



SIFÓN AHORRA ESPACIO LAVAMANOS

REFERENCIA	PAQUETE
935550001	Und.



SIFÓN EN P DOBLE LAVAPLATOS

REFERENCIA	PAQUETE
935540001	Und.

DESAGÜES

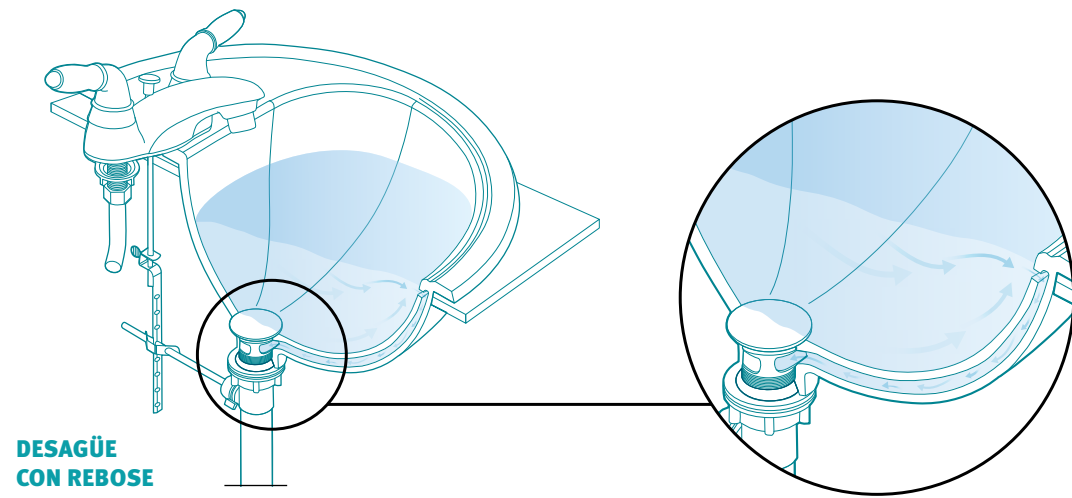

DESAGÜE CON REBOSE



DESAGÜE PUSH METÁLICO CON REBOSE

REFERENCIA	PAQUETE	COLOR
935395551	Und.	Metal A
 719625551	Und.	Metal A

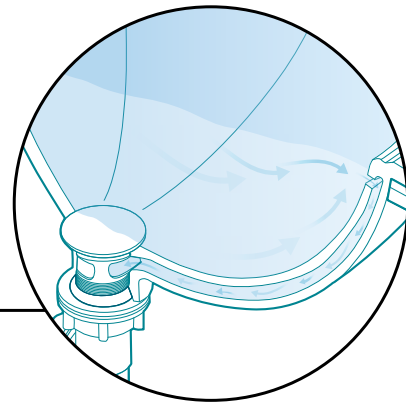

DESAGÜE PUSH PLÁSTICO CON REBOSE



REFERENCIA	PAQUETE
935415551	Und.
 719585551	Und.

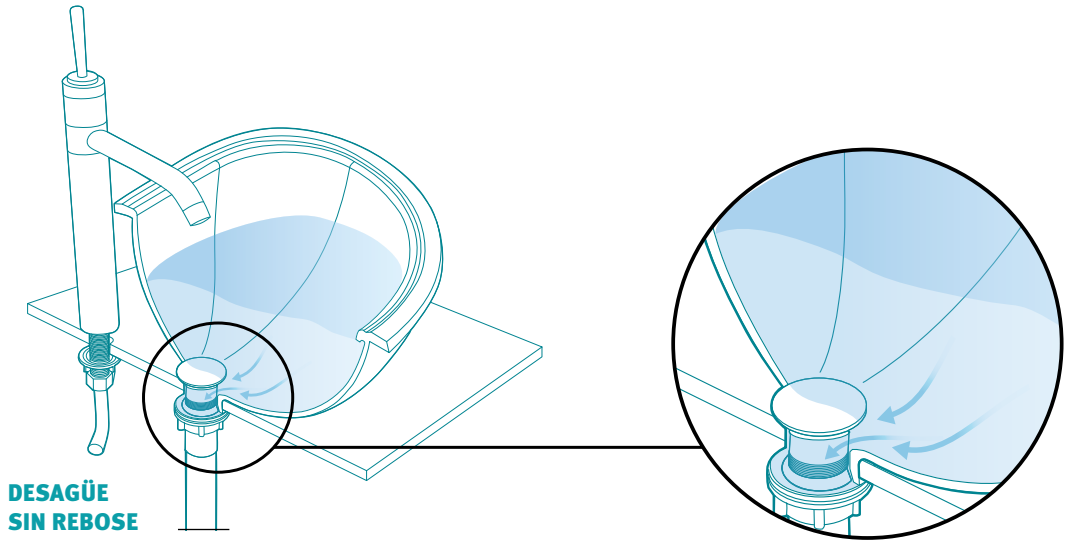

DESAGÜE SIN REBOSE



DESAGÜE PUSH METÁLICO SIN REBOSE

REFERENCIA	PAQUETE	COLOR
935385551	Und.	Cromo A
 719575551	Und.	Cromo A

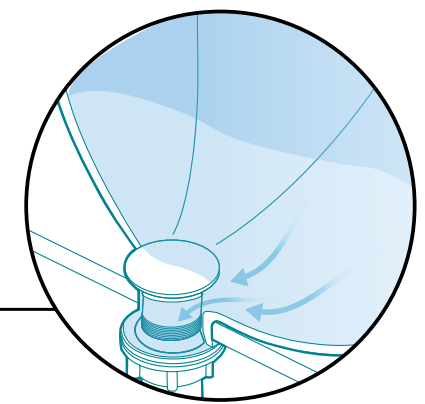

DESAGÜE PUSH PLÁSTICO SIN REBOSE



REFERENCIA	PAQUETE
935405551	Und.
 719595551	Und.



DESAGÜE SENCILLO CON REBOSE

REFERENCIA	PAQUETE
931100001	Und.
 935333331	x6
 360035551	Und.



DESAGÜE AUTOMÁTICO CON REBOSE

REFERENCIA	PAQUETE
931000001	Und.
 015943331	x6
 360015551	Und.



DESAGÜE SENCILLO SIN REBOSE

REFERENCIA	PAQUETE
931120001	Und.
 931125551	Und.



DESAGÜE AUTOMÁTICO SIN REBOSE

REFERENCIA	PAQUETE
931110001	Und.

CANASTILLAS

100%
ACERO INOXIDABLE





CANASTILLA 4 PULGADAS METÁLICA

REFERENCIA	PAQUETE
937260001	Und.
 937265551	Und.



CANASTILLA 4 PULGADAS CROMADA

REFERENCIA	PAQUETE
935170001	Und.
 935175551	Und.
 935263331	x6



CANASTILLA 4 PULGADAS GRIS

REFERENCIA	PAQUETE
935030001	Und.
 935273331	x6



CANASTILLA 2 PULGADAS CROMADA

REFERENCIA	PAQUETE
935200001	Und.



REGULACIONES Y ACOPLÉS

BENEFICIOS Y RECOMENDACIONES

- Diferentes acabados que complementan los ambientes de baño y cocina.
- Productos plásticos y metálicos.
- Todos nuestros productos cumplen con la Resolución 0501, no contaminan el agua con plomo.

USOS

- Lavamanos, lavaplatos, sanitarios, lavadoras y calentadores.

KIT REGULACIONES + ACOPLS

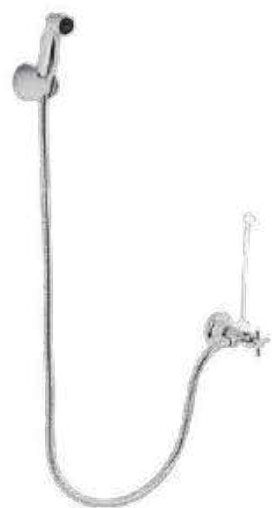

ATRIBUTOS ESPECIALES

- Manguera con largo de 120 cm.
- Kit listo para instalación, este producto incluye: regulación metálica doble, acople para conexión, manguera, soporte y ducha.
- Manguera súper flexible con recubrimiento metálico.
- Bajo consumo, 6,5 litros por minuto.
- Accionador metálico.
- Ahorra espacio.

KIT BIDÉ CON REGULACIÓN DOBLE

REFERENCIA	PAQUETE
937330001	Und.
937335551	Und.



KIT DE INSTALACIÓN REGULACIÓN + ACOPLS SANITARIO

REFERENCIA	PAQUETE	DIÁMETRO
931630001	Und.	NPT 1/2"



KIT REGULACIÓN SATINADA + ACOPLS SANITARIO

REFERENCIA	PAQUETE
967690001	Und.
967725551	Und.



KIT REGULACIÓN SATINADA + ACOPLS LAVAMANOS / LAVAPLATOS

REFERENCIA	PAQUETE
967680001	Und.
967715551	Und.



REGULACIÓN PLÁSTICA + ACOPLS SANITARIO

REFERENCIA	PAQUETE	DIÁMETRO
967350001	Und.	1/2 pulg.
967363331	x6	1/2 pulg.
967355551	Und.	1/2 pulg.



REGULACIÓN PLÁSTICA + ACOPLS LAVAMANOS / LAVAPLATOS

REFERENCIA	PAQUETE	DIÁMETRO
967150001	Und.	1/2 pulg.
967023331	x6	1/2 pulg.
380265551	Und.	1/2 pulg.



KIT BRIDA + REGULACIÓN + GRIFLEX SANITARIO

REFERENCIA	PAQUETE
937635551	Und.
947635551	Und.

BENEFICIOS

Sello hermético contra al suelo.

Permite corregir desplazamientos de hasta 2 cm.

Empaque de selle que garantiza el selle de gases.

Casquetes decorativos que evitan la humedad.

Tornillos de anclaje plásticos.

Versátil para tuberías de 3" y 4"

Todos nuestros productos cumplen con la Resolución 0501, no contaminan el agua con plomo.

CARACTERÍSTICAS

Brida de alta calidad, resistente a la humedad, ovalada, con orificios para sujetar fuertemente al piso y al sanitario.

MATERIAL

ABS.

USO

Sanitarios.

COLOR

Negro.



BRIDA SANITARIA

REFERENCIA	PAQUETE
737620001	Und.
737625551	Und.



REGULACIONES



LLAVE LAVADORA CRUCETA

REFERENCIA	PAQUETE	DIÁMETRO
797360001	Und.	¾ pulg.
797365551	Und.	¾ pulg.



REGULACIÓN SATINADA LAVADORA

REFERENCIA	PAQUETE	DIÁMETRO
967700001	Und.	¾ pulg.
967705551	Und.	¾ pulg.



REGULACIÓN DOBLE SALIDA

REFERENCIA	PAQUETE	DIÁMETRO
967310001	Und.	½ pulg.
967315551	Und.	½ pulg.



REGULACIÓN SATINADA

REFERENCIA	PAQUETE	DIÁMETRO
967670001	Und.	½ pulg.
967673331	x6	½ pulg.
957815551	Und.	½ pulg.



REGULACIÓN PLÁSTICA

REFERENCIA	PAQUETE	DIÁMETRO
957900001	Und.	½ pulg.
957903331	x6	½ pulg.
957905551	Und.	½ pulg.
PK7035551	x3	½ pulg.



REGULACIÓN METÁLICA CRUCETA

REFERENCIA	PAQUETE	DIÁMETRO
797340001	Und.	½ pulg.
797343331	x3	½ pulg.
797345551	Und.	½ pulg.



BENEFICIOS

- Posee un filtro.
- Abren y cierra rápidamente.
- Cartucho cerámico de suave accionamiento.

PRESIÓN DE SERVICIO

Presión de trabajo manométrica recomendada entre 138 kPa (20 psi) hasta 860 kPa (125 psi).

TEMPERATURA DE USO RECOMENDADA

De 4°C a 66°C (40°F a 151°F).

CAPACIDAD DE FUNCIONAMIENTO

Resistencia de la manija al torque superior a 5.1 N-m (45 lb-pulg).

Capacidad de flujo o caudal, máximo 36 l/min (9.6 gpm) a 138 kPa (20 psi).

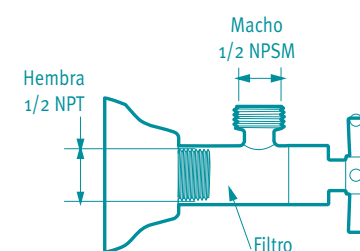

REGULACIÓN LAVADORA PLÁSTICA

REFERENCIA	PAQUETE	DIÁMETRO
967660001	Und.	¾ pulg.
967665551	Und.	¾ pulg.



REGULACIÓN DOBLE SALIDA PLÁSTICA

REFERENCIA	PAQUETE	DIÁMETRO
967620001	Und.	½ pulg.
967623331	x6	½ pulg.
967625551	Und.	½ pulg.

ACOPLES

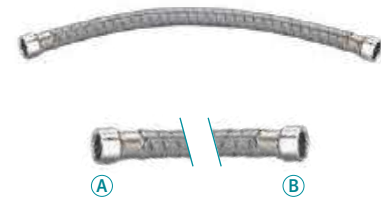

ACOPLE CALENTADOR 40 CM

REFERENCIA	PAQUETE	DIÁMETRO
023940001	Und.	½ pulg.
032635551	Und.	½ pulg.



ACOPLE LAVADORA PVC

REFERENCIA	PAQUETE	DIÁMETRO
022990001	Und.	
022993331	x6	
022995551	Und.	

ESPECIFICACIONES DE PRODUCTO

- Diámetro interno 14,5 mm.
- Capacidad de flujo o caudal 10 l/min.

PRESIÓN DE SERVICIO

Presión de trabajo manométrica recomendada entre 20 psi a 125 psi.

TEMPERATURA DE USO

De 5°C hasta 65°C (41°F a 149°F).

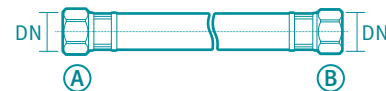

GRIFLEX LAVAMANOS / LAVAPLATOS 70 CM MONOCONTROL

REFERENCIA	PAQUETE	DIÁMETRO
380510001	Und.	
380513331	x6	
380515551	Und.	

RECUBRIMIENTOS (ACABADOS)

- Recubrimiento en acero inoxidable resistente a la corrosión, pelado y decoloración por agua.
- Resistente al efecto de jabones y limpiadores de tocador.
- Condición de servicio recomendada, uso institucional y residencial.
- Dos diferentes medidas para cada una de las necesidades.

PRESIÓN DE SERVICIO

Presión de trabajo manométrica recomendada entre 20 psi a 125 psi.

TEMPERATURA DE USO

De 5°C hasta 65°C (41°F a 149°F).

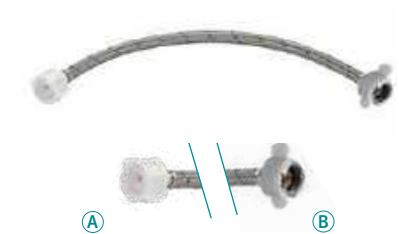
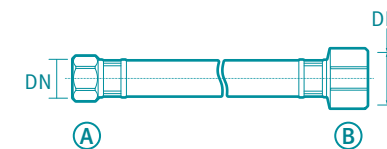

ACOPLE SANITARIO 40 CM

REFERENCIA	PAQUETE	DIÁMETRO
022950001	Und.	½ pulg.
022955551	Und.	½ pulg.

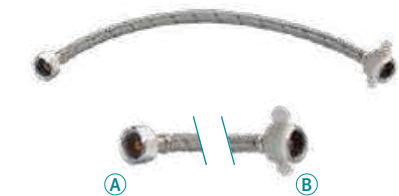

ACOPLE LAVAMANOS / LAVAPLATOS 40 CM

REFERENCIA	PAQUETE	DIÁMETRO
022930001	Und.	½ pulg.
022933331	x4	½ pulg.
022935551	Und.	½ pulg.

ACOPLES

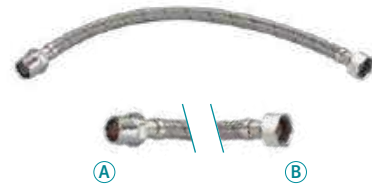

EXTENSOR DE ACOPLE 40 CM

REFERENCIA	PAQUETE	DIÁMETRO
022970001	Und.	½ pulg.
022975551	Und.	½ pulg.

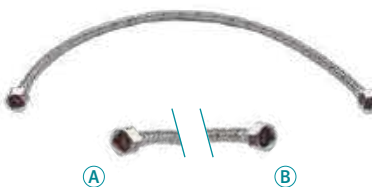

ACOPLE LAVAMANOS / LAVAPLATOS 60 CM

REFERENCIA	PAQUETE	DIÁMETRO
022940001	Und.	
022945551	Und.	

RECUBRIMIENTOS (ACABADOS)

- Trenzado en acero inoxidable resistente a la corrosión, pelado y decoloración por agua.
- Resistente al efecto de jabones y limpiadores de tocador.
- Condición de servicio recomendada, uso institucional y residencial.
- 2 diferentes medidas para cada una de las necesidades.
- Medidas de 7/8 sanitario y 1/2 para lavamanos y lavaplatos

PRESIÓN DE SERVICIO

Presión de trabajo manométrica recomendada entre 20 psi a 125 psi.

TEMPERATURA DE USO

De 5°C hasta 65°C (41°F a 149°F).

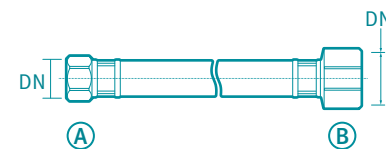

RECUBRIMIENTOS (ACABADOS)

- Trenzado en acero inoxidable resistente a la corrosión, pelado y decoloración por agua.
- Resistente al efecto de jabones y limpiadores de tocador.
- Condición de servicio recomendada, uso institucional y residencial.
- Dos diferentes medidas para cada una de las necesidad
- Medidas de 7/8 sanitario y 1/2 para lavamanos y lavaplatos

PRESIÓN DE SERVICIO

Presión de trabajo manométrica recomendada entre 20 psi a 125 psi.

TEMPERATURA DE USO

De 5°C hasta 65°C (41°F a 149°F).

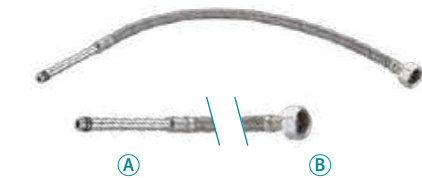
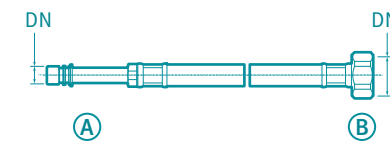

ACOPLE MONOCONTROL LAVAMANOS / LAVAPLATOS 50 CM

REFERENCIA	PAQUETE	DIÁMETRO
022980001	Und.	½ pulg.
022983331	x4	½ pulg.
032735551	Und.	½ pulg.

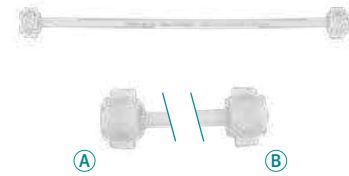

**GRIFLEX
LAVAMANOS / LAVAPLATOS 40 CM**

REFERENCIA	PAQUETE	DIÁMETRO
380140001	Und.	½ pulg.
380183331	x12	½ pulg.
022155551	Und.	½ pulg.

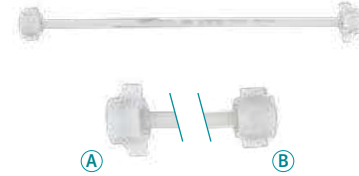

**GRIFLEX
SANITARIO 40 CM**

REFERENCIA	PAQUETE	DIÁMETRO
380130001	Und.	½ - 7/8 pulg.
380135551	Und.	½ - 7/8 pulg.
380193331	x12	½ - 7/8 pulg.

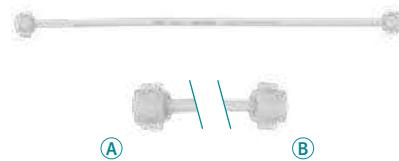

**GRIFLEX
LAVAMANOS / LAVAPLATOS 60 CM**

REFERENCIA	PAQUETE	DIÁMETRO
380120001	Und.	½ pulg.
380123331	x12	½ pulg.
022755551	Und.	½ pulg.

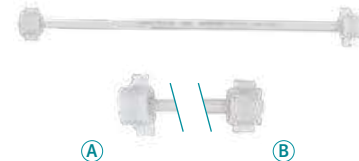

**GRIFLEX
SANITARIO 55 CM**

REFERENCIA	PAQUETE	DIÁMETRO
380503331	x12	
022765551	Und.	

LLAVES TERMINALES

BENEFICIOS Y RECOMENDACIONES

- Estos productos no contaminan el agua, metálicos 100% de su cuerpo en latón.
- Respaldo y garantía GRIVAL.
- Diseñados para trabajo pesado.
- Todos nuestros productos cumplen con la Resolución 0501, no contaminan el agua con plomo.

USOS

- Para jardín, con conexión y manejo de riego.
- Para cocina y zona de lavandería.



LLAVE COCINA



- Incluye aireador, lo que permite disfrutar de un chorro espumoso y un consumo de 8,3 l/min.
- Ideal para Lavaderos, Cocinas y otras áreas.
- Calidad GRIVAL, que nos permite ofrecer una garantía de 5 años.
- Acabado cromado.
- Accionamiento tipo cruceta.
- Incluye escudo flotante para fácil instalación.

LLAVE COCINA CRUCETA

REFERENCIA	PAQUETE
979120001	Und.
 979125551	Und.

LLAVES DE JARDÍN



CARTUCHO CERÁMICO

LLAVE JARDÍN PESADA SATINADA

REFERENCIA	PAQUETE
977920001	Und.
 977923331	x4
 380345551	Und



CARTUCHO A COMPRESIÓN

LLAVE JARDÍN LIVIANA SATINADA

REFERENCIA	PAQUETE
977220001	Und.
 977263331	x6



CIERRE PASO DE BOLA

LLAVE JARDÍN DE BOLA

REFERENCIA	PAQUETE
791000001	Und.
 791005551	Und.

LLAVES DE JARDÍN



CARTUCHO CERÁMICO

LLAVE JARDÍN PESADA CROMADA

REFERENCIA	PAQUETE
977930001	Und.
 977933331	x4
 380335551	Und



CARTUCHO A COMPRESIÓN

LLAVE DE JARDÍN LIVIANA CROMADA

REFERENCIA	PAQUETE
977210001	Und.
 977253331	x6



CARTUCHO CERÁMICO

LLAVE JARDÍN PALANCA

REFERENCIA	PAQUETE
979110001	Und.
 979113331	x6
 380435551	Und.



CARTUCHO A COMPRESIÓN

LLAVE JARDÍN CORRIENTE

REFERENCIA	PAQUETE
797270001	Und.
 797273331	Und.
 797275551	Und.



CARTUCHO A COMPRESIÓN

LLAVE JARDÍN BRONCE

REFERENCIA	PAQUETE
797280001	Und.
 797283331	x6
 797285551	Und.

VÁLVULAS DE CONTROL

TODAS LAS VÁLVULAS METÁLICAS

- No contaminan el agua, 100% latón.
- Resistentes a la corrosión, pelado y decoloración por agua.
- Recubrimientos no tóxicos.
- Respaldo marca GRIVAL.

VÁLVULAS DE BOLA METÁLICAS

- Abren y cierran rápidamente con tan solo 1/4 de giro de la manija.
- Pueden ser instaladas en cualquier posición.
- Permiten distinguir a larga distancia si se encuentran en posición abierta o cerrada.

VÁLVULAS DE COMPUERTA

- Se recomienda en procesos de baja frecuencia de operación.
- Para una óptima operación se recomienda abrir o cerrar totalmente la válvula.

VÁLVULAS DE BOLA PVC

- Diseñadas para soluciones de alta presión.
- Manijas contramarcadas GRIVAL.
- Válvulas para trabajo pesado SCHEDULE 80.

VÁLVULAS DE CHEQUE

- Permite el paso del fluido en un solo sentido y restringe el retroceso del mismo.
- Su instalación siempre debe estar orientada según el sentido del flujo. Posee una marcación de dirección para asegurar su correcta instalación y óptimo funcionamiento.
- Facilita la operación de equipos de bombeo al mantener carga de fluido en un extremo de la línea.

- Todos nuestros productos cumplen con la Resolución 0501, no contaminan el agua con plomo.

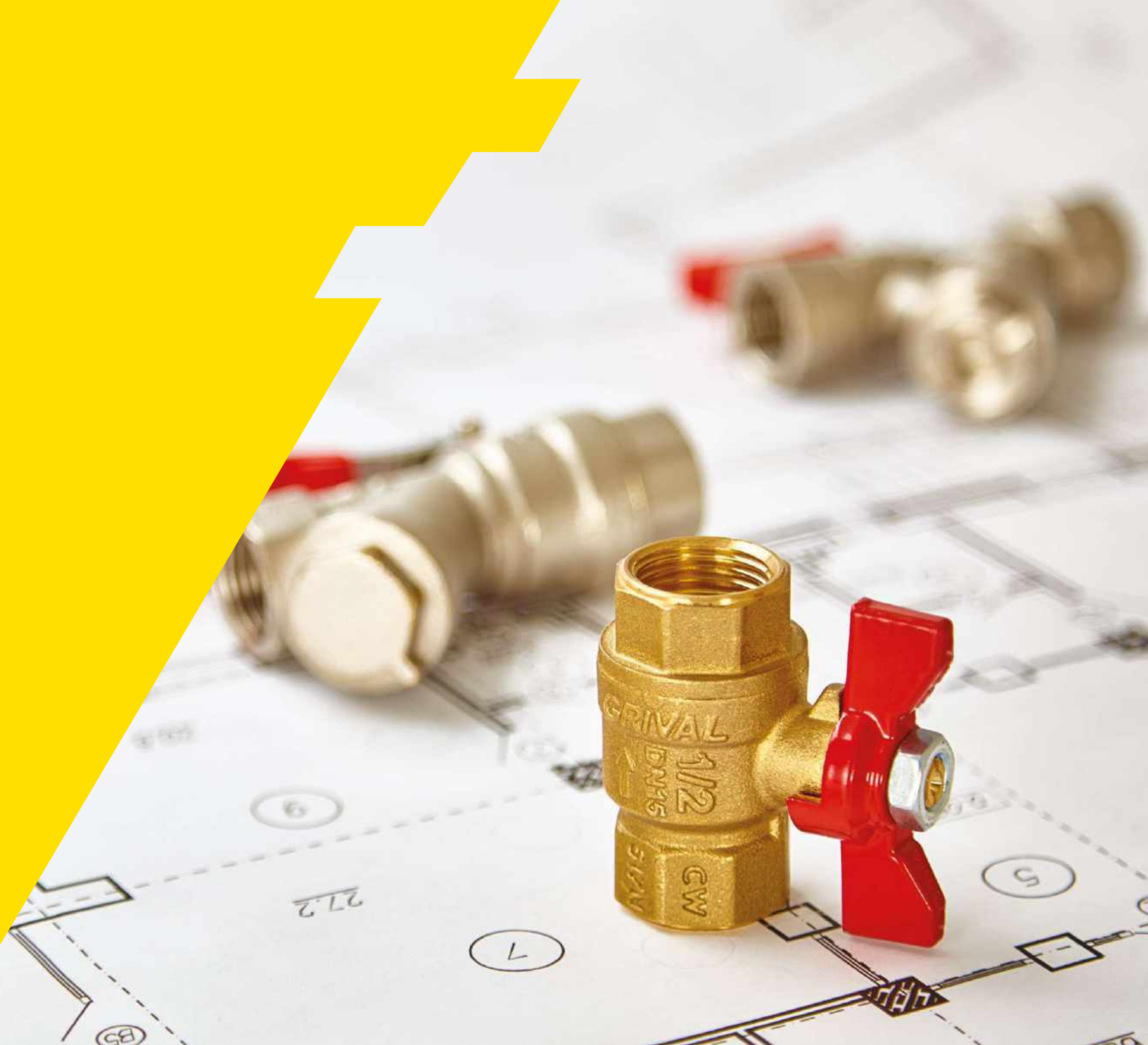



KIT TANQUE RESERVA

REFERENCIA	PAQUETE	DIÁMETRO
967045551	Und.	½ pulg.
 977045551	Und.	½ pulg.

INSTALACIÓN

En tubería vertical y horizontal, incluye válvula con flotador antibacterial y válvula con sistema de bola.

ATRIBUTOS ESPECIALES

CHEQUE CORTINA:

Ideal para evitar sobre costos de agua en tanques elevados y tubería residencial, asegura que el agua de la red no se devuelva a la red del acueducto y genere un doble consumo.

VÁLVULA CON FLOTADOR

Con protección UV y antibacterial.

VÁLVULA CON SISTEMA DE BOLA

Con accionamiento rápido, 1/4 de vuelta.

PRESIÓN DE SERVICIO

Resiste hasta 150 psi.

CARACTERÍSTICAS

Flotador con protección UV y antibacterial.

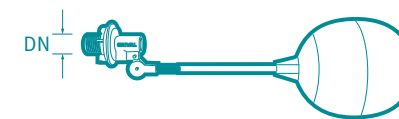

VÁLVULA PARA TANQUE RESERVA METÁLICA

REFERENCIA	PAQUETE	DIÁMETRO
967063331	x4	½ pulg.

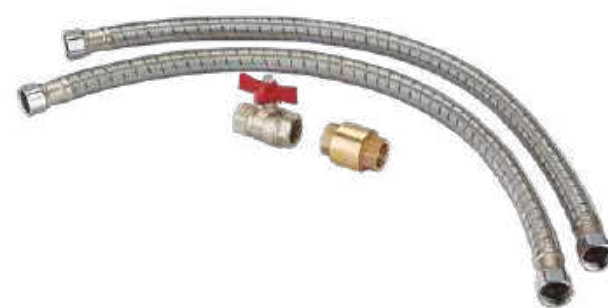

KIT CALENTADOR

REFERENCIA	PAQUETE	DIÁMETRO
967075551	x2	½ pulg.
 977075551	Und.	½ pulg.

VENTAJAS

Cheque resorte Ideal para evitar sobrecostos de agua en tanques elevados y tubería residencial, puesto que con cortes de agua asegura que el agua de la red no se devuelva a la red de acueducto y genere un doble consumo.

ATRIBUTOS ESPECIALES

ACOPLE CALENTADOR

- Máxima flexibilidad facilitando su instalación.
- Acoples fabricados en Acero 304 resistente a la corrosión.

VÁLVULA CON SISTEMA DE BOLA

- Permite un accionamiento rápido, 1/4 de vuelta.

CARACTERÍSTICAS

Válvula de llenado flotador.

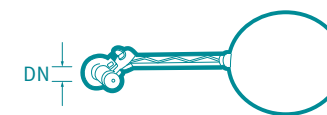

VÁLVULA TANQUE RESERVA PLÁSTICA

REFERENCIA	PAQUETE	DIÁMETRO
806400001	Und.	½ pulg.

VÁLVULAS DE BOLA METÁLICAS



VÁLVULA DE BOLA ANTIFRAUDE AGUA

REFERENCIA	PAQUETE	DIÁMETRO
717430001	Und.	½ pulg.

ATRIBUTOS

- Manija con precinto de seguridad.
- Ideal para instalaciones a la entrada de la red.
- Diseñadas y fabricadas para garantizar una larga vida útil.

PRESIÓN DE SERVICIO

De 4°C a 66°C (40°F a 151°F)

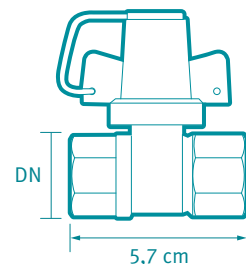

PRESIÓN DE SERVICIO

Presión de trabajo manométrica recomendada del agua 2000 kPa (290 psi).

TEMPERATURA DE USO RECOMENDADA

De 4°C a 66°C (40°F a 151° F).

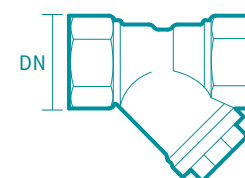

IMPORTANCIA DE INSTALAR FILTROS EN Y

Los filtros en Y son una solución de fácil instalación y bajo mantenimiento que protegen los artefactos hidráulicos de la vivienda, reteniendo partículas e impurezas provenientes de la red, aumentando la vida útil de griferías y sanitarios.

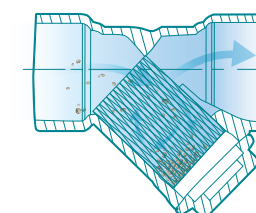

FLUJO DE AGUA

En dirección de la flecha, los residuos se acumulan en el depósito.



FILTRO INTEGRADO

FILTRO EN Y

REFERENCIA	PAQUETE	DIÁMETRO
797210001	Und.	½ pulg.
797215551	Und.	½ pulg.



VÁLVULA DE BOLA MANIJA MARIPOSA

REFERENCIA	PAQUETE	DIÁMETRO
797060001	Und.	½ pulg.
PK7015551	x3	½ pulg.
797063331	x6	½ pulg.
797065551	Und.	½ pulg.
717420001	Und.	¾ pulg.

PRESIÓN DE SERVICIO

- Presión de trabajo manométrica máxima del agua 3000 kPa (435 psi).

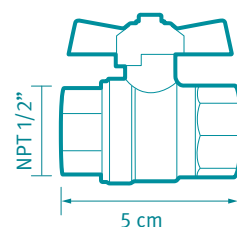

PRESIÓN DE SERVICIO

- Presión de trabajo manométrica recomendada del agua 1000 kPa (145 psi).
- Diámetro: 1/2" y 3/4"
- Presión de trabajo manométrica recomendada del agua 1600 kPa (232 psi).
- Diámetro: 1", 1-1/4", 1-1/2" y 2"

TEMPERATURA DE USO RECOMENDADA

De 4°C a 66°C (40°F a 151°F).

CAPACIDAD DE FUNCIONAMIENTO

La vida útil de la unidad de cierre supera los 5.000 ciclos a 138 kPa (50 ± 5 psi).

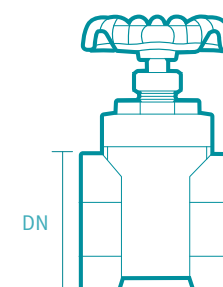

VÁLVULA COMPUERTA

REFERENCIA	PAQUETE	DIÁMETRO
707630001	Und.	½ pulg.
767013331	x6	½ pulg.
767015551	Und.	½ pulg.
707640001	Und.	¾ pulg.
767023331	x3	¾ pulg.
767025551	Und.	¾ pulg.
707650001	Und.	1 pulg.
767035551	Und.	1 pulg.
797725551	Und.	1 ¼ pulg.

VÁLVULAS DE BOLA METÁLICAS

VÁLVULA MANIJA MARIPOSA HEMBRA-MACHO

REFERENCIA	PAQUETE	DIÁMETRO
797070001	Und.	½ pulg.
 797075551	Und.	½ pulg.



PRESIÓN DE SERVICIO

Presión de trabajo manométrica máxima del agua 3000 kPa (345 psi) presión mínima recomendada 138 kPa (20 psi).

TEMPERATURA DE USO RECOMENDADA







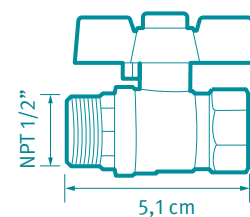

De 4° C a 16° C (40° F y 61° F).

CAPACIDAD DE FUNCIONAMIENTO

Vida útil de la unidad de cierre 5.000 ciclos a 138 kPa (50±5 psi).



VÁLVULA DE BOLA MANIJA PALANCA

REFERENCIA	PAQUETE	DIÁMETRO
797000001	Und.	½ pulg.
 797003331	x6	½ pulg.
 797005551	Und.	½ pulg.
797010001	Und.	¾ pulg.
 797013331	x3	¾ pulg.
 797015551	Und.	¾ pulg.
797020001	Und.	1 pulg.
 797023331	x3	1 pulg.
 797025551	Und.	1 pulg.
797030001	Und.	1 ¼ pulg.
 797035551	Und.	1 ¼ pulg.
797040001	Und.	1 ½ pulg.
 797045551	Und.	1 ½ pulg.



PRESIÓN DE SERVICIO

Presión de trabajo manométrica máxima del agua 3000 kPa (435 psi).

TEMPERATURA DE USO RECOMENDADA

De 4° C a 66° C (40° F a 151° F).

CAPACIDAD DE FUNCIONAMIENTO

La vida útil de la unidad de cierre supera los 5.000 ciclos a 138 kPa (50 ± 5 psi).

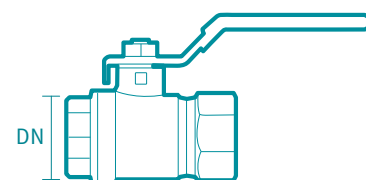

PRESIÓN DE SERVICIO

Presión de trabajo manométrica máxima del agua 1620 kPa (235 psi).

TEMPERATURA DE USO RECOMENDADA

De 4° C a 27° C (40° F a 81° F).

VÁLVULA TRABAJO PESADO

SCHEDULE 80

CAPACIDAD DE FUNCIONAMIENTO

La vida útil de la unidad de cierre supera los 5.000 ciclos a 138 kPa (50 ± 5 psi).

VÁLVULA BOLA PVC SOLDAR

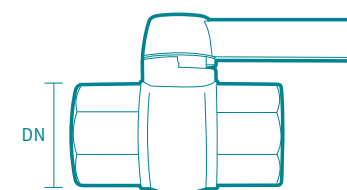

VÁLVULA BOLA PVC ROSCAR

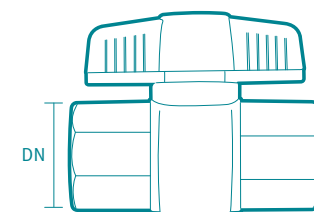

VÁLVULAS BOLA PVC







VÁLVULAS DE BOLA PVC



VÁLVULA DE BOLA PESADA PVC ROSCAR

REFERENCIA	PAQUETE	DIÁMETRO
797550001	Und.	½ pulg.
 797553331	x6	½ pulg.
 797555551	Und.	½ pulg.
797560001	Und.	¾ pulg.
 797565551	Und.	¾ pulg.
797570001	Und.	1 pulg.
 797575551	Und.	1 pulg.
797580001	Und.	1 ½ pulg.
 797585551	Und.	1 ½ pulg.
797595551	Und.	2 pulg.

VÁLVULA DE BOLA PESADA PVC SOLDAR

REFERENCIA	PAQUETE	DIÁMETRO
797500001	Und.	½ pulg.
 797503331	x6	½ pulg.
 797505551	Und.	½ pulg.
797510001	Und.	¾ pulg.
 797513331	x6	¾ pulg.
 797515551	Und.	¾ pulg.
797520001	Und.	1 pulg.
 797525551	Und.	1 pulg.
797530001	Und.	1 ½ pulg.
 797535551	Und.	1 ½ pulg.
797540001	Und.	2 pulg.
 797545551	Und.	2 pulg.

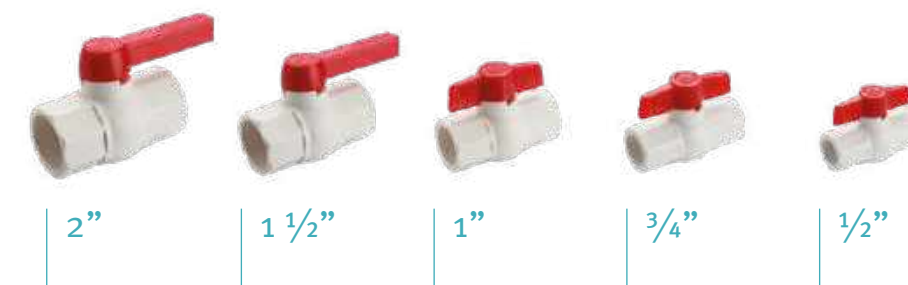

VÁLVULAS DE CHEQUE

PRESIÓN DE SERVICIO

Presión de trabajo manométrica recomendada del agua 1034 kPa (150 psi).

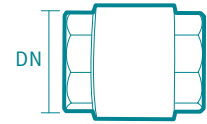

CHEQUE RESORTE

REFERENCIA	PAQUETE	DIÁMETRO
797180001	Und.	½ pulg.
797183331	x3	½ pulg.
797185551	Und.	½ pulg.
797195551	Und.	¾ pulg.
797203331	x3	1 pulg.
797205551	Und.	1 pulg.

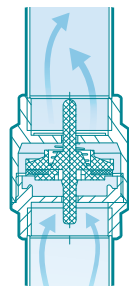

PASO DE AGUA

Flujo en dirección a la flecha de la válvula.

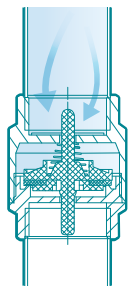

BLOQUEO DE AGUA

Flujo en dirección contraria a la flecha de la válvula.



1"



¾"



½"

PRESIÓN DE SERVICIO

Presión de trabajo manométrica recomendada del agua 1034 kPa (150 psi).

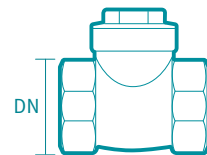

CHEQUE CORTINA

REFERENCIA	PAQUETE	DIÁMETRO
797150001	Und.	½ pulg.
797153331	x6	½ pulg.
797155551	Und.	½ pulg.
797160001	Und.	¾ pulg.
797163331	x3	¾ pulg.
797165551	Und.	¾ pulg.
797170001	Und.	1 pulg.
797173331	x3	1 pulg.
797175551	Und.	1 pulg.

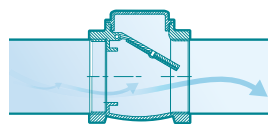

PASO DE AGUA

Flujo en dirección de la flecha de la válvula.

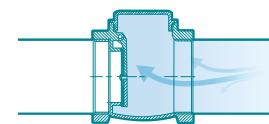

BLOQUEO DE AGUA

Flujo en dirección contraria a la flecha de la válvula.



1"



¾"



½"

CONTROLADORES DE PRESIÓN

CONTROL DE PRESIÓN

Con GRIVAL ahora usted puede lograr el control total de la presión del agua, obteniendo el mejor desempeño de todos los artefactos hidráulicos de su casa (griferías, duchas y sanitarios).

PRESURIZADORES DE AGUA

- Aumenta de manera instantánea la presión del agua proveniente de la red, mejorando el funcionamiento de griferías para lavamanos, duchas y lavaplatos.





BOMBA PRESURIZADORA G1

REFERENCIA	PAQUETE
PZ7010001	Und.

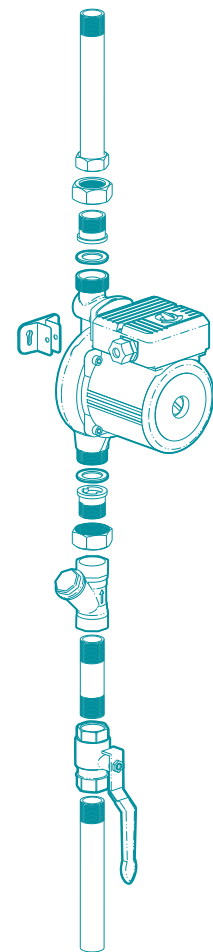

CONTENIDO DE LA CAJA G1 - 9 MCA

- Acople metálico + empaque.
- Filtro metálico 1/2" REF: 797210001 GRIVAL.
- Anclaje pared.

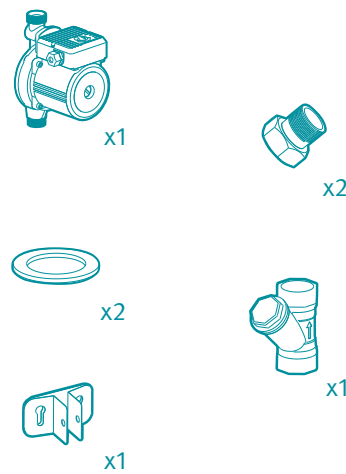

ESPECIFICACIONES DE PRODUCTO

Modelo: G1 - 9 mca.
 Conexión: 3/4" bspm.
 Carcasa de la bomba: Aluminio fundido.
 Protección IP.
 Accesorios incluidos: set de 2 acoples de 1/2" bspf con empaque y 1 filtro en y metálico de 1/2" bspf.

DATOS ELÉCTRICOS

(110V, 60 Hz).
 Potencia 120 W.
 Peso neto: 2.4 kg.

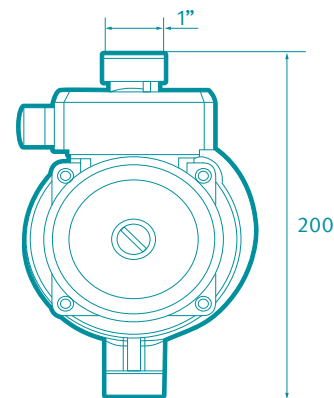

- ENCENDIDO AUTOMÁTICO**
Control de flujo incorporado, la bomba se activa cada vez que se abra un grifo o una ducha y al cerrarla se apaga nuevamente.
- BAJO CONSUMO DE ENERGÍA**
Consumo de energía equivalente a 2 bombillos de 60 watts.
- SILENCIOSO**
Muy bajo nivel de ruido [45dB] equivalente a un susurro suave.

ESPECIFICACIONES DE PRODUCTO

Modelo: G2 - 12 mca.
 Conexión: 1" bspm.
 Carcasa de la bomba: Aluminio fundido.
 Protección IP.
 Accesorios incluidos: set de 2 acoples de 3/4" bspf con empaque y 1 filtro tipo y metálico de 3/4" bspf.

DATOS ELÉCTRICOS

(110V, 60 Hz).
 Potencia 275 W.
 Peso neto: 4.5 kg.

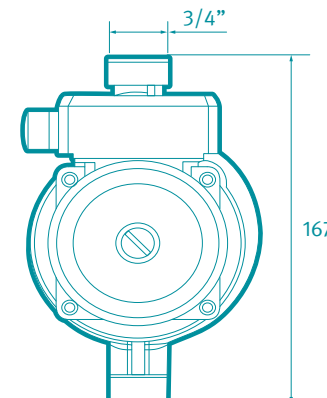

- ENCENDIDO AUTOMÁTICO**
Control de flujo incorporado, la bomba se activa cada vez que se abra un grifo o una ducha y al cerrarla se apaga nuevamente.
- BAJO CONSUMO DE ENERGÍA**
Consumo de energía equivalente a 4 bombillos de 60 watts.
- SILENCIOSO**
Muy bajo nivel de ruido [45dB] equivalente a un susurro suave.



BOMBA PRESURIZADORA G2

REFERENCIA	PAQUETE
PZ7020001	Und.

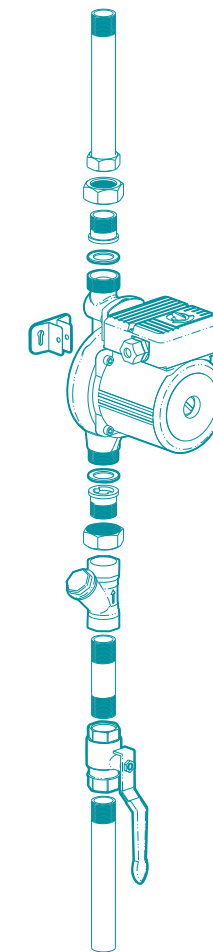

CONTENIDO DE LA CAJA G2 - 12 MCA

- Acople metálico + empaque.
- Filtro metálico 1/2" REF: 797210001 GRIVAL.
- Anclaje pared.

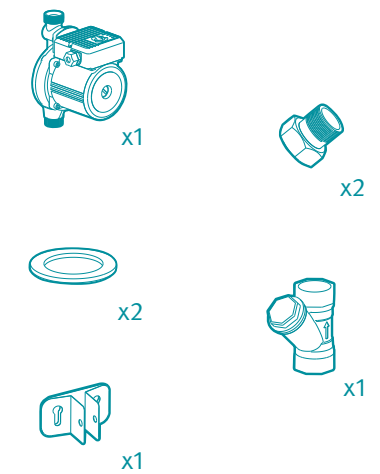

REJILLAS

BENEFICIOS Y RECOMENDACIONES

- Resistente a la corrosión, pelado y decoloración por agua.
- Resistente al efecto de jabones y limpiadores de tocador.
- Recubrimiento no tóxico.
- Condición de servicio recomendada, uso doméstico.
- Respaldo y garantía GRIVAL.
- Fabricada con acero inoxidable quirúrgico 304.

USOS

- Duchas.
- Baños.
- Cocinas.
- Zona de lavandería.
- Balcones.
- Piscina y zonas húmedas.





REJILLA PISO CLÁSICA

REFERENCIA	PAQUETE	MEDIDA
937220001	Und.	10 x 10 cm
937225551	Und.	10 x 10 cm



BENEFICIOS

- Cumple con norma (NTC 5302).
- Rejilla en acero inoxidable.
- Sistema anticucarachas y antiolores.
- Para instalación con tubería sanitaria de PVC de 1-1/2", 2" y 3"
- Recomendado para uso doméstico en área de duchas, baños, cocinas, lavandería y balcones.

ESPECIFICACIONES DEL PRODUCTO

- Resistente a la corrosión, pelado y decoloración.
- Resistente al efecto de jabones y limpiadores de tocador.
- Recubrimientos no tóxicos.



REJILLA PISO CONTEMPORÁNEA

REFERENCIA	PAQUETE	MEDIDA
937210001	Und.	10 x 10 cm
937215551	Und.	10 x 10 cm



REJILLA PISO VANGUARDISTA

REFERENCIA	PAQUETE	MEDIDA
937200001	Und.	10 x 10 cm
937203331	x3	10 x 10 cm
937205551	Und.	10 x 10 cm

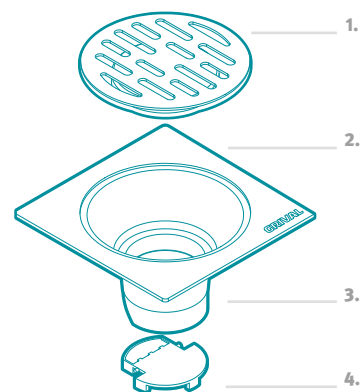

1. Rejilla.
2. Soporte rejilla.
3. Sosco.
4. Sistema anti olores.

ESPECIFICACIONES DE PRODUCTO

La rejilla redonda 3P CR ha sido diseñada para trabajar en perfecta armonía con el espacio; inspirada en las necesidades del consumidor latinoamericano dando como resultado un producto robusto y funcional.

RECUBRIMIENTOS (ACABADOS)

- Resistente a la corrosión, pelado y decoloración por agua.
- Recubrimientos no tóxicos.
- Productos para uso doméstico.

SUPERIOR

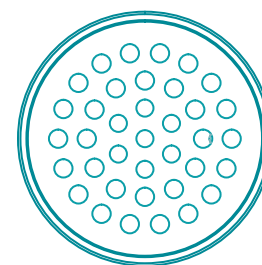

FRONTAL

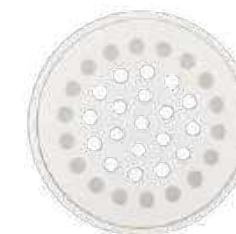
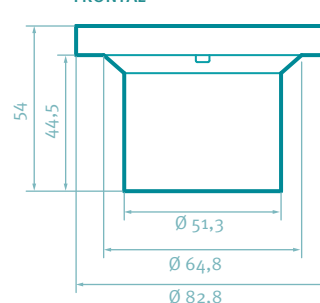

REJILLA REDONDA PLÁSTICA BLANCA

REFERENCIA	PAQUETE	DIÁMETRO
937190001	Und.	3 pulg.



REJILLA REDONDA PLÁSTICA GRIS

REFERENCIA	PAQUETE	DIÁMETRO
937060001	Und.	3 pulg.



REJILLA REDONDA PLÁSTICA CROMADA

REFERENCIA	PAQUETE	DIÁMETRO
937143331	x6	3 pulg.
937075551	Und.	3 pulg.

REJILLAS VENTILACIÓN



Garantiza la ventilación y flujo de aire en ambientes cerrados. Ideal para ventilación de baños y cocinas.

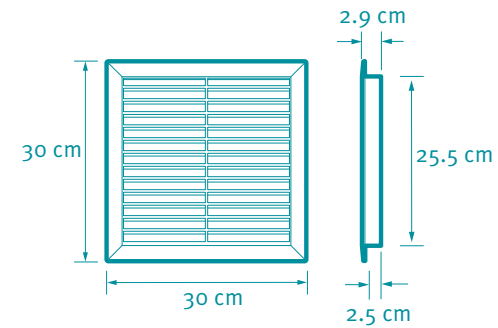

REJILLA DE VENTILACIÓN

REFERENCIA	PAQUETE	MEDIDA
937000001	Und.	30 x 30 cm
937005551	Und.	30 x 30 cm

REJILLAS VENTILACIÓN



Garantiza la ventilación y flujo de aire en ambientes cerrados. Ideal para ventilación de baños y cocinas.

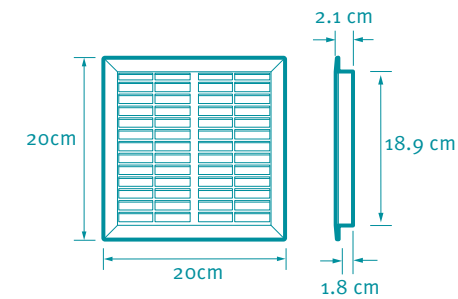

REJILLA SUCCIÓN

REFERENCIA	PAQUETE	MEDIDA
937025551	Und.	20 x 20 cm

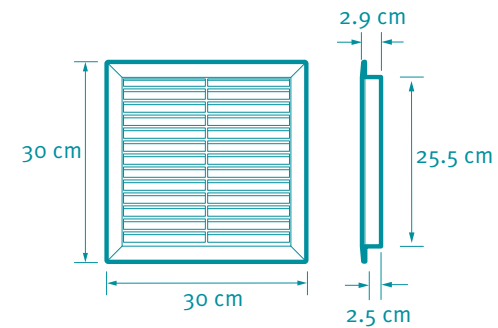

REJILLA DE VENTILACIÓN

REFERENCIA	PAQUETE	MEDIDA
937300001	Und.	30 x 30 cm
937605551	Und.	30 x 30 cm

TAPA REGISTRO

Práctico elemento decorativo y funcional con el cual podrá proteger su registros y mejorar la apariencia de sus baños y cocinas.

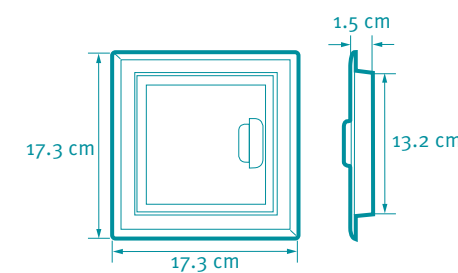

TAPA REGISTRO

REFERENCIA	PAQUETE	MEDIDA
937033331	x6	17.3 x 17.3 cm
937035551	Und.	17.3 x 17.3 cm

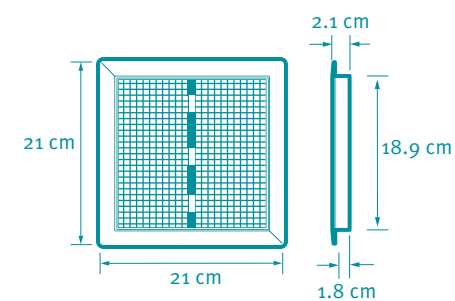

REJILLA VENTILACIÓN GAS

REFERENCIA	PAQUETE	MEDIDA
937013331	x6	21 x 21 cm
937015551	Und.	21 x 21 cm

AHORRADORES DE AGUA

BENEFICIOS Y RECOMENDACIONES

- Diferentes niveles de ahorro de agua
- Compatibles con griferías.
- Compatibilidad con griferías GRIVAL.
- Presión máxima de 125 psi.

USOS

- Griferías lavamanos.
- Griferías lavaplatos.



90%
AHORRO DE AGUA

AHORRADOR DOBLE FUNCIÓN
0,5 GPM - 2.2 GPM

REFERENCIA

021680001

Acabado cromo

Tipo de rosca: Externa

Tipo de chorro: Lluvia, cristalino



56%
AHORRO DE AGUA

AHORRADOR DIRIGIBLE
BLANCO 2.2 GPM

REFERENCIA

021670001

Acabado cromo

Tipo de rosca: Externa, interna

Tipo de chorro: Lluvia, espumoso



80%
AHORRO DE AGUA

AHORRADOR
1.0 GPM

REFERENCIA

021540001

Acabado cromo

Tipo de rosca: Externa

Tipo de chorro: Espumoso



80%
AHORRO DE AGUA

AHORRADOR
1.0 GPM

REFERENCIA

021550001

Acabado cromo

Tipo de rosca: Interna

Tipo de chorro: Espumoso



80%
AHORRO DE AGUA

AHORRADOR
1.0 GPM

REFERENCIA

021560001

Acabado cromo

Tipo de rosca: Externa

Tipo de chorro: Cristalino



80%
AHORRO DE AGUA

AHORRADOR
1.0 GPM

REFERENCIA

021570001

Acabado cromo

Tipo de rosca: Interna

Tipo de chorro: Cristalino



GPM : Galones Por Minuto
Ahorro calculado basado en consumo de agua de griferías convencionales (18 l/min)



**DESVIADOR
TELEDUCHA**

REFERENCIA	PAQUETE
934100001	Und.



**TAPÓN DECORATIVO
PLÁSTICO CROMADO**

REFERENCIA	PAQUETE
0118800001	Und.

MEJORAMIENTO DEL AGUA

Grival tiene en su portafolio una oferta de filtros para el mejoramiento del agua en el hogar, las cuatro etapas de filtrado ajustan a las diferentes a las diferentes necesidades del consumidor.



ETAPA 1 - MICROTECH:

Su potencia de filtración se caracteriza por crear una barrera que impide el paso de micro partículas al purificar el agua, lo que permite que el agua salga limpia.



ETAPA 2 - C-SENSE:

El carbón activado está diseñado para reducir olores mejorar la apariencia del agua y su sabor, reduciendo el cloro y los contaminantes orgánicos.



ETAPA 3 - ADVANCE:

Su sistema facilita la absorción de metales pesados y materia orgánica. Además, bloquea los sedimentos que no se hayan filtrado en la etapa 1 y 2.



ETAPA 4 - CLEAR PLUS:

Elimina por completo los olores y mejora totalmente la apariencia del agua. Su cliente podrá contar con agua fresca, natural y de sabor puro.



FILTROS



**FILTRO DE AGUA
4 ETAPAS BAJO MESÓN**

REFERENCIA	PAQUETE
797775551	Und.

- Diseño moderno y compacto.
- Optimiza el espacio en la cocina.
- Fácil de usar.
- Cartucho reemplazable.



**FILTRO DE AGUA
3 ETAPAS BAJO MESÓN**

REFERENCIA	PAQUETE
797765551	Und.

- Diseño moderno y compacto.
- Optimiza el espacio en la cocina.
- Fácil de usar.
- Cartucho reemplazable.



**FILTRO DE AGUA
1 ETAPA BAJO MESÓN**

REFERENCIA	PAQUETE
797425551	Und.

- Práctica y fácil de usar.
- Cartucho reemplazable.
- Ajustable a cualquier grifería.
- Incluye adaptadores.



**FILTRO DE AGUA
1 ETAPA SOBRE MESÓN**

REFERENCIA	PAQUETE
797385551	Und.

- Diseño compacto y moderno.
- Fácil de usar.
- Cartuchos reemplazables.



**FILTRO DE AGUA
2 ETAPAS SOBRE MESÓN**

REFERENCIA	PAQUETE
797395551	Und.

- Diseño moderno y compacto.
- Fácil de usar.
- Cartuchos reemplazables.
- Incluye grifo para salida de agua filtrada.



**FILTRO DE AGUA
2 ETAPAS BAJO MESÓN**

REFERENCIA	PAQUETE
797435551	Und.

- Diseño moderno y compacto.
- Fácil de usar.
- Cartuchos reemplazables.
- Incluye grifo para salida de agua filtrada.



JARRA FILTRANTE

REFERENCIA	PAQUETE
797415551	Und.

- Diseño moderno y compacto.
- Práctica y fácil de usar.
- Capacidad 2,5 litros.
- Cartucho reemplazable.



**FILTRO PARA CONEXIÓN
A GRIFO**

REFERENCIA	PAQUETE
797405551	Und.

- Práctico y fácil de usar.
- Cartucho reemplazable.
- Ajustable a cualquier grifería.
- Incluye adaptadores.

CARTUCHOS



**CARTUCHO
FILTRO 4 ETAPAS**

REFERENCIA	PAQUETE
797815551	Und.



**CARTUCHO
FILTRO 3 ETAPAS**

REFERENCIA	PAQUETE
797805551	Und.



**CARTUCHO
FILTRO 2 ETAPAS**

REFERENCIA	PAQUETE
797475551	Und.



**CARTUCHO
FILTRO 1 ETAPA**

REFERENCIA	PAQUETE
797465551	Und.



**CARTUCHO
JARRA FILTRANTE**

REFERENCIA	PAQUETE
797455551	Und.



**CARTUCHO
PARA FILTRO**

REFERENCIA	PAQUETE
797485551	Und.

GRIFERÍA TANQUE

BENEFICIOS Y RECOMENDACIONES

- Repuestos originales para los sanitarios Corona.
- Productos fabricados en polímeros de alta ingeniería.
- Garantiza los consumos óptimos para el ahorro de agua en los Sanitarios



CORONA Y GRIVAL
COMPATIBLES

PRODUCTOS
COMPATIBLES CON



corona

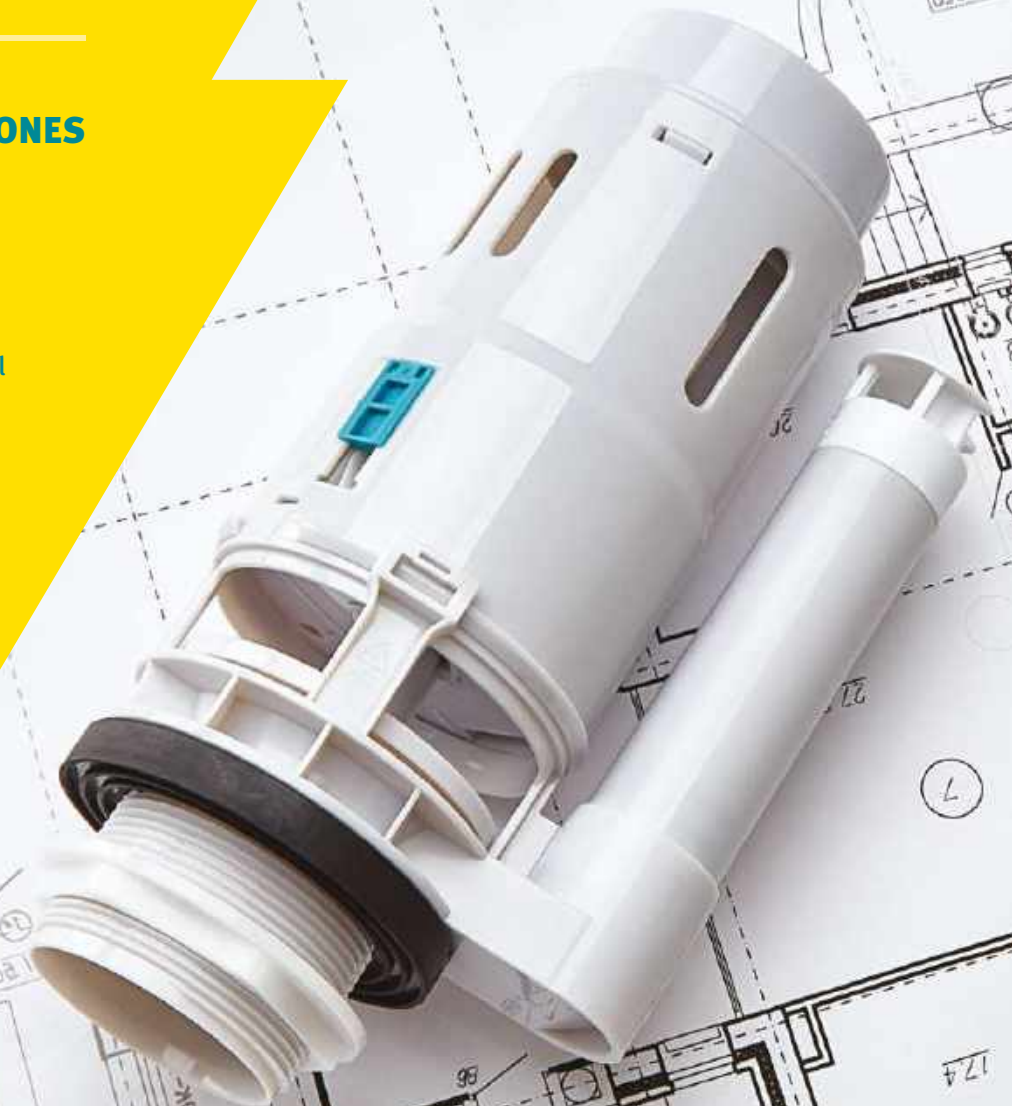

KIT GRIFERÍA TANQUE



KIT DOBLE DESCARGA SANITARIOS DE 1 PIEZA / SANITARIO SALIDA DE 2 PULGADAS

REFERENCIA	PAQUETE
818270001	Und.
 818275551	Und.



KIT UNIVERSAL PLUS CON MANIJA GRIVAL DE 2 PIEZAS/ SANITARIOS SALIDA DE 2 PULGADAS

REFERENCIA	PAQUETE
O22880001	Und.
 O22885551	Und.



KIT UNIVERSAL PLUS + BOTÓN 38 MM DE 2 PIEZAS/ SANITARIOS SALIDA DE 2 PULGADAS

REFERENCIA	PAQUETE
818290001	Und.



KIT ATLAS / NUKI 26 CM SANITARIO 2 PIEZAS / SALIDA DE 2 PULGADAS

REFERENCIA	PAQUETE
806320001	Und.
 806325551	Und.



KIT ATLAS / NUKI 32 CM

REFERENCIA	PAQUETE
806310001	Und.
 806313331	x6
 806315551	Und.

VÁLVULAS DE LLENADO



KIT LAGUNA SANITARIO DE 2 PIEZAS / SANITARIO SALIDA DE 2 PULGADAS

REFERENCIA	PAQUETE
803133331	Und.



KIT DUAL MASTER DE 2 PIEZAS / SANITARIO SALIDA DE 2 PULGADAS

REFERENCIA	PAQUETE
O22620001	Und.
 O22625551	Und.



KIT DOBLE DESCARGA SANITARIOS DE 2 PIEZAS / SANITARIO SALIDA 2 PULGADAS

REFERENCIA	PAQUETE
818250001	Und.
 818255551	Und.



KIT HIDROPLUS 26 CM SANITARIO DE 2 PIEZAS / SANITARIO SALIDA 2 PULGADAS

REFERENCIA	PAQUETE
 806363331	x3



VÁLVULA G300 (ALTA)

REFERENCIA	PAQUETE
O23070001	Und.

VÁLVULAS DE LLENADO



HIDRO 26 CM (BAJA)

REFERENCIA	PAQUETE
806373331	Und.



ATLAS PLUS 26 CM

REFERENCIA	PAQUETE
806330001	Und.
 806333331	x6
 806335551	Und.



ATLAS PLUS 32 CM

REFERENCIA	PAQUETE
806343331	x6
 806355551	Und.





MASTER UNIVERSAL

REFERENCIA	PAQUETE
022600001	Und.
 022603331	x3



UNIVERSAL PLUS

REFERENCIA	PAQUETE
022850001	Und.
 022853331	x3
 022855551	Und.
 022856661	x6



UNIVERSAL PLUS BAJA

REFERENCIA	PAQUETE
022900001	Und.

VÁLVULAS DE DESCARGA

VÁLVULAS DUAL AJUSTABLE

Estas válvulas tienen el tubo de rebose con altura graduable, fácil de ajustar a sanitarios de diferentes alturas. El sistema de descarga Dual permite ahorro de agua al tener una opción de descarga parcial (líquidos) y descarga completa (sólidos), fácil instalación, 100% compatible con sanitarios Corona.



DUAL AJUSTABLE DOBLE DESCARGA SANITARIO 2 PIEZAS / SANITARIO SALIDA 2 PULGADAS

REFERENCIA	PAQUETE
799310001	Und.
 816515551	Und.



DUAL AJUSTABLE DOBLE DESCARGA SANITARIO 1 PIEZA / SANITARIO SALIDA 2 PULGADAS

REFERENCIA	PAQUETE
799140001	Und.
 816475551	Und.



DUAL AJUSTABLE DOBLE DESCARGA SANITARIO 2 PIEZAS / SANITARIO SALIDA 3 PULGADAS

REFERENCIA	PAQUETE
799290001	Und.
 816495551	Und.



DUAL AJUSTABLE DOBLE SALIDA 1 PIEZA / SANITARIO SALIDA DE 3 PULGADAS

REFERENCIA	PAQUETE
816420001	Und.
 816525551	Und.



VÁLVULA DE UNA DESCARGA SANITARIO DE 1 PIEZA / SANITARIO SALIDA DE 3 PULGADAS

REFERENCIA	PAQUETE
816600001	Und.



VÁLVULA DE UNA DESCARGA SANITARIOS DE 2 PIEZAS / SANITARIO SALIDA DE 3 PULGADAS

REFERENCIA	PAQUETE
816610001	Und.



**PIAMONTE
3 PULGADAS**

REFERENCIA	PAQUETE
798850001	Und.



**NUKI 26 CM +
BOTÓN DE 38 MM**

REFERENCIA	PAQUETE
738000001	Und.
 738005551	Und.



NUKI 32 CM

REFERENCIA	PAQUETE
806100001	Und.
 806103331	x6
 806105551	Und.



**NUKI SANITARIO 1 PIEZA /
SANITARIO SALIDA 2 PULGADAS**

REFERENCIA	PAQUETE
738020001	Und.
 738025551	Und.



**NUKI 32 CM +
BOTÓN 38 MM**

REFERENCIA	PAQUETE
738010001	Und.
 738015551	Und.





NUKI 26 CM

REFERENCIA	PAQUETE
806200001	Und.
 806203331	x6
 806205551	Und.





FLAPPER ADVANCE BCA

REFERENCIA	PAQUETE
023440001	Und.
 023443331	x8
 023463331	x12
 033425551	Und.



FLAPPER ADVANCE CORRIENTE

REFERENCIA	PAQUETE
 023503331	x12
 023453331	x8



SELLO ELITE

REFERENCIA	PAQUETE
017671111	Und.



SELLO CLÁSICO BLANCO

REFERENCIA	PAQUETE
010060001	Und.
 018073331	x8



TAPA HAPPY VERDE

REFERENCIA	PAQUETE
032450001	Und.



TAPA HAPPY NEGRA

REFERENCIA	PAQUETE
031600001	Und.



TAPA HAPPY ROJA

REFERENCIA	PAQUETE
032250001	Und.



TAPA HAPPY NARANJA

REFERENCIA	PAQUETE
032240001	Und.



TAPA HAPPY BLANCA

REFERENCIA	PAQUETE
039080001	Und.



TAPA HAPPY BONE

REFERENCIA	PAQUETE
031030001	Und.



TAPA HAPPY AZUL

REFERENCIA	PAQUETE
031150001	Und.



TAPA MONTECARLO

REFERENCIA	PAQUETE
909089991	Und.

BOTONES

MANIJAS



BOTÓN 38 MM + CATAPULTA

REFERENCIA	PAQUETE
025280001	Und.
025285551	Und.



BOTÓN 58 MM + CATAPULTA

REFERENCIA	PAQUETE
025020001	Und.



BOTÓN 58 MM PARA SANITARIO SMART

REFERENCIA	PAQUETE
024940001	Und.
 024945551	Und.



MANIJA MONTECARLO

REFERENCIA	PAQUETE
018640001	Und.



MANIJA CROMO

REFERENCIA	PAQUETE
010100001	Und.



MANIJA GRIVAL

REFERENCIA	PAQUETE
937500001	Und.
 937505551	Und.
 937513331	Und.



BOTÓN SINGLE AVANTI

REFERENCIA	PAQUETE
018090001	Und.



BOTÓN DUAL REDONDO

REFERENCIA	PAQUETE
021530001	Und.
 021535551	Und.



BOTÓN DUAL ALONGADO

REFERENCIA	PAQUETE
024070001	Und.
 024075551	Und.

Pico

Tapa
manija

Manija

Cartucho

Escudo

Aireador

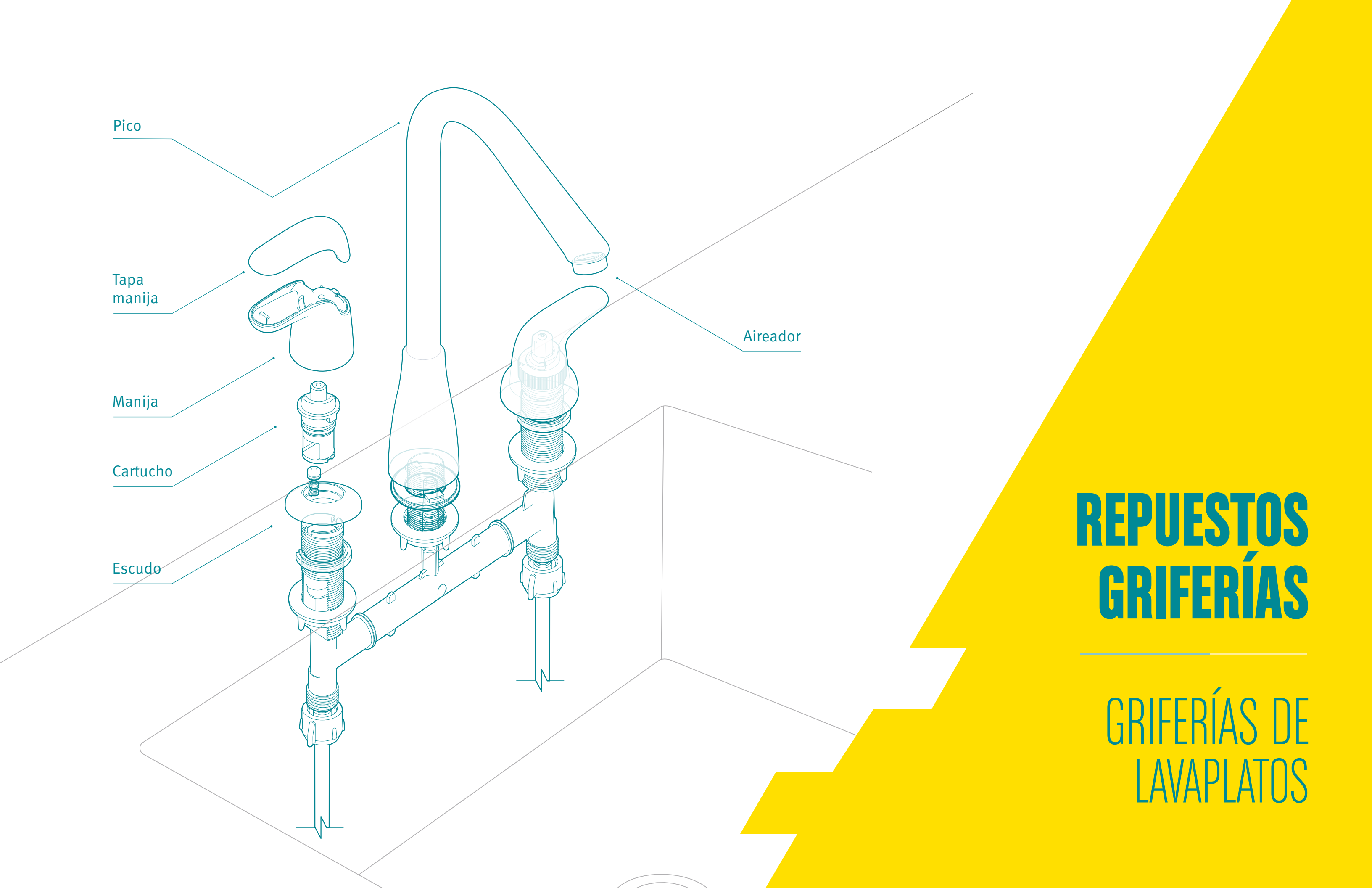

REPUESTOS GRIFERÍAS

GRIFERÍAS DE LAVAPLATOS



LAVAPLATOS 8 PULGADAS

BRIZA

	MANIJA	PICO	CARTUCHO	AIREADOR
				
REF.: 325685551 325695551 325653331	MANIJA BRIZA REF.: 025060001	NARIZ TUBULAR PLÁSTICA REF.: 034010001	UNIDAD CIERRE 90 AST. PLÁSTICA REF.: 019090001	AIREADOR HEMBRA 5.7 L X MIN REF.: 024460001

TAMARA

	MANIJA	PICO	CARTUCHO	AIREADOR
				
REF.: 635035551 635045551 635033331	MANIJA ARTESA REF.: 24780001  025205551	NARIZ TUBULAR PLÁSTICA REF.: 034010001	UNIDAD CIERRE 90 AST. PLÁSTICA REF.: 019090001	AIREADOR HEMBRA 5.7 L X MIN REF.: 024460001

ARTESA

	MANIJA	PICO	CARTUCHO	AIREADOR
				
REF.: AE5055551 AE5065551 AE5073331	MANIJA ARTESA REF.: 024780001  025205551	NARIZ TUBULAR PLÁSTICA REF.: 034010001	UNIDAD CIERRE 90 AST. PLÁSTICA REF.: 019090001	AIREADOR HEMBRA 5.7 L X MIN REF.: 024460001

NOGAL LT

	MANIJA	PICO	CARTUCHO	AIREADOR
				
REF.: 455920001 455910001 455923331 455145551	MANIJA NOGAL REF.: 024710001  025185551	PICO GRU REF.: 024990001	UNIDAD CIERRE 90 AST. PLÁSTICA REF.: 019090001	AIREADOR MACHO 5.7 L X MIN REF.: 024470001

LAVAPLATOS 8 PULGADAS

DALIA

	MANIJA	PICO	CARTUCHO	AIREADOR
				
REF.: 435100001 435080001 435003331	MANIJA NOGAL REF.: 024710001  025185551	PICO GRU REF.: 024990001	UNIDAD CIERRE 90 AST. PLÁSTICA REF.: 019090001	AIREADOR MACHO 5.7 L X MIN REF.: 024470001

BALTA CRUCETA

	MANIJA	PICO	CARTUCHO	AIREADOR
				
REF.: 415020001 415000001 415273331	MANIJA BALTA CRUCETA REF.: 021270001	NARIZ TUBULAR PLÁSTICA REF.: 034010001	UNIDAD CIERRE 90 AST. PLÁSTICA REF.: 019090001	AIREADOR MACHO 5.7 L X MIN REF.: 024470001

BALTA PALANCA

	MANIJA	PICO	CARTUCHO	AIREADOR
				
REF.: 415020001 415000001 415273331	MANIJA BALTA PALANCA REF.: 021300001	NARIZ TUBULAR PLÁSTICA REF.: 034010001	UNIDAD CIERRE 90 AST. PLÁSTICA REF.: 019090001	AIREADOR MACHO 5.7 L X MIN REF.: 024470001

ALUVIA PALANCA SOBREPONER

	MANIJA	PICO	CARTUCHO	AIREADOR
				
REF.: AV5110001 AV5100001 AV5113331	MANIJA ALUVIA PALANCA REF.: 024730001  025125551	PICO ARA REF.: 024980001	CARTUCHO ALUVIA REF.: 024800001	AIREADOR MACHO 5.7 L X MIN REF.: 024470001

LAVAPLATOS 8 PULGADAS

ALUVIA TRICETA SOBREPONER

	MANIJA	PICO	CARTUCHO	AIREADOR
				
REF.: AV5130001 AV5120001 AV5133331	REF.: O24750001  O25135551	REF.: O24980001	REF.: O24800001	REF.: O24470001

ALUVIA PALANCA

	MANIJA	PICO	CARTUCHO	AIREADOR
				
REF.: AV5070001 AV5050001 AV5073331	REF.: O24730001  O25125551	REF.: O24980001	REF.: O19090001	REF.: O24470001

ALUVIA TRICETA

	MANIJA	PICO	CARTUCHO	AIREADOR
				
REF.: AV5080001 AV5060001 AV5083331	REF.: O24750001  O25135551	REF.: O24980001	REF.: O19090001	REF.: O24470001

ATHENEA

	MANIJA	PICO	CARTUCHO	AIREADOR
				
REF.: 415165551	REF.: O21270001	REF.: O24970001	REF.: O19090001	REF.: O24460001

LAVAPLATOS 8 PULGADAS

NOGAL

	MANIJA	PICO	CARTUCHO	AIREADOR
				
REF.: 455145551 455140001	REF.: O24710001  O2518555	REF.: O24970001	REF.: O19090001	REF.: O24460001

MONACO

	MANIJA	PICO	CARTUCHO	AIREADOR
				
REF.: MC5000001 MC5010001	REF.: O21270001	REF.: O24970001	REF.: O19090001	REF.: O24460001

SEVILLA

	MANIJA	PICO	CARTUCHO	AIREADOR
				
REF.: CV5000001 CV5010001	REF.: O24710001  O25185551	REF.: O24970001	REF.: O19090001	REF.: O24460001

MARRUECOS

	MANIJA	PICO	CARTUCHO	AIREADOR
				
REF.: 795500001		REF.: O24970001	REF.: O14680001 DER. O14690001 IZQ.  O14685551 DER.  O14695551 IZQ.	REF.: O24460001

LAVAPLATOS 8 PULGADAS

DRAA	MANIJA	PICO	CARTUCHO	AIREADOR
				
REF.: DR5025551		PICO LAVAPLATOS DRA REF.: 709500001		AIREADOR MACHO 5.7 L X MIN REF.: 024470001

VAAL	MANIJA	PICO	CARTUCHO	AIREADOR
				
REF.: VV5005551		PICO HIGC ARC REF.: 024970001	UNIDAD CERÁMICA CORTO REF.: 014680001 DER. 014690001 IZQ.  014685551 DER.  014695551 IZQ.	AIREADOR CACHE TT REF.: 025010001

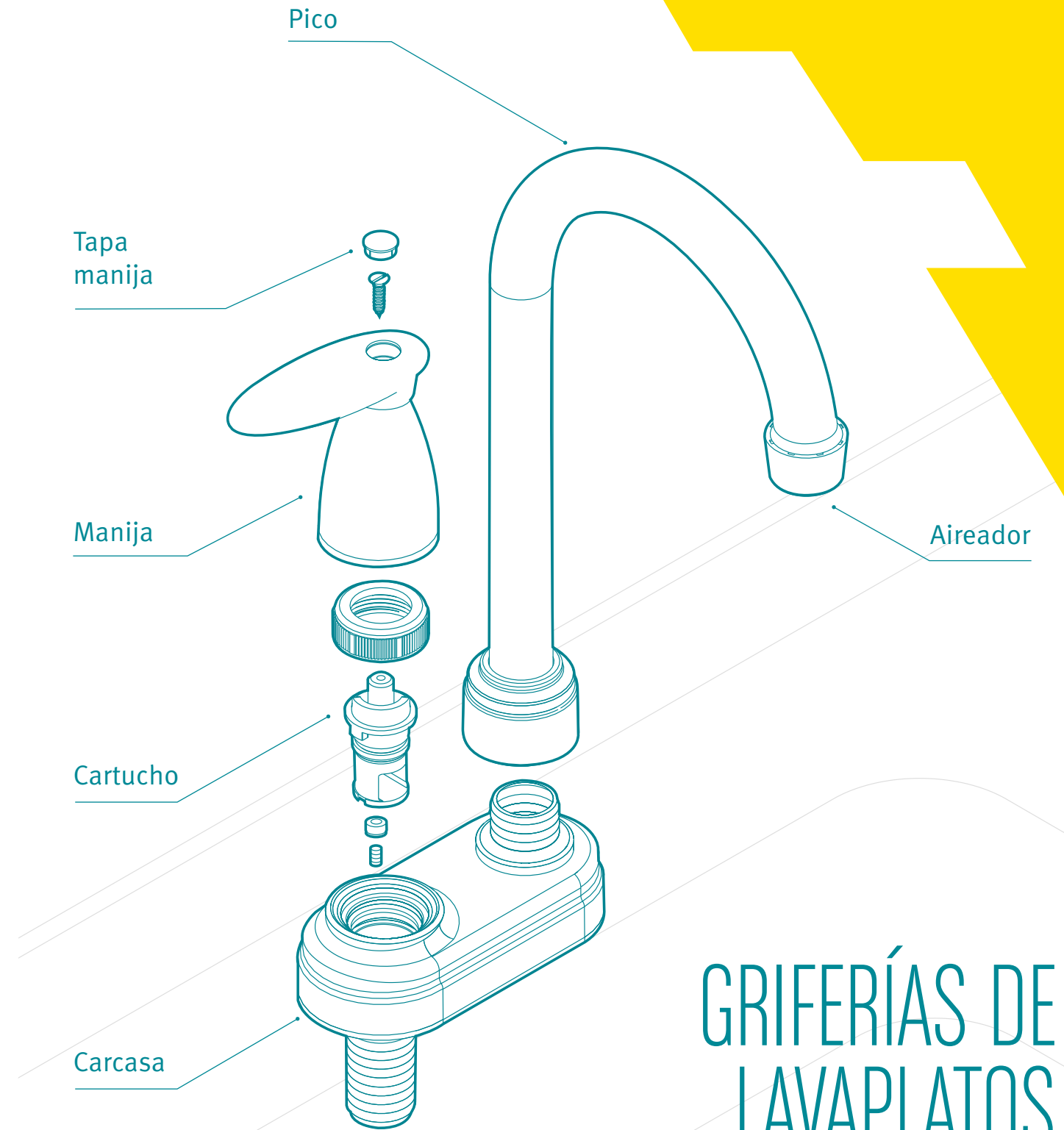

GRIFERÍAS DE LAVAPLATOS SENCILLO

LAVAPLATOS SENCILLO

BRIZA



REF.:
32566551
32567551
32564331

MANIJA



MANIJA BRIZA

REF.:
025060001

PICO



NARIZ TUBULAR
PLÁSTICA

REF.:
034010001

CARTUCHO



UNIDAD CIERRE 90 AST.
PLÁSTICA

REF.:
019090001

AIREADOR



AIREADOR HEMBRA 5.7
L X MIN

REF.:
024460001

TAMARA



REF.:
63500551
63501551
63502331

MANIJA



MANIJA ARTESA

REF.:
024780001
 02520551

PICO



NARIZ TUBULAR
PLÁSTICA

REF.:
034010001

CARTUCHO



UNIDAD CIERRE 90 AST.
PLÁSTICA

REF.:
019090001

AIREADOR



AIREADOR HEMBRA 5.7
L X MIN

REF.:
024460001

ARTESA



REF.:
AE502551
AE503551
AE504331

MANIJA



MANIJA ARTESA

REF.:
024780001
 02520551

PICO



NARIZ TUBULAR
PLÁSTICA

REF.:
034010001

CARTUCHO



UNIDAD CIERRE 90 AST.
PLÁSTICA

REF.:
019090001

AIREADOR



AIREADOR HEMBRA 5.7
L X MIN

REF.:
024460001

NOGAL LT



REF.:
455940001
455930001
45594331

MANIJA



MANIJA NOGAL

REF.:
024710001
 02518551

PICO



PICO GRU

REF.:
024990001

CARTUCHO



UNIDAD CIERRE 90 AST.
PLÁSTICA

REF.:
019090001

AIREADOR



AIREADOR MACHO 5.7
L X MIN

REF.:
024470001

LAVAPLATOS SENCILLO

DALIA



REF.:
435060001
435040001
43501331

MANIJA



MANIJA NOGAL

REF.:
024710001
 02518551

PICO



PICO GRU

REF.:
024990001

CARTUCHO



UNIDAD CIERRE 90 AST.
PLÁSTICA

REF.:
019090001

AIREADOR



AIREADOR MACHO 5.7
L X MIN

REF.:
024470001

BALTA CRUCETA



REF.:
415130001
415120001
41529331

MANIJA



MANIJA BALTA CRUCETA

REF.:
021270001

PICO



NARIZ TUBULAR
PLÁSTICA

REF.:
034010001

CARTUCHO



UNIDAD CIERRE 90 AST.
PLÁSTICA

REF.:
019090001

AIREADOR



AIREADOR HEMBRA 5.7
L X MIN

REF.:
024460001

BALTA PALANCA



REF.:
415150001
415140001
41530331

MANIJA



MANIJA BALTA
PALANCA

REF.:
021300001

PICO



NARIZ TUBULAR
PLÁSTICA

REF.:
034010001

CARTUCHO



UNIDAD CIERRE 90 AST.
PLÁSTICA

REF.:
019090001

AIREADOR



AIREADOR MACHO 5.7
L X MIN

REF.:
024470001

ALUVIA PALANCA



REF.:
AV5030001
AV5010001
AV503331

MANIJA



MANIJA ALUVIA
PALANCA

REF.:
024730001
 02512551

PICO



PICO ARA

REF.:
024980001

CARTUCHO



UNIDAD CIERRE 90 AST.
PLÁSTICA

REF.:
024790001

AIREADOR



AIREADOR MACHO 5.7
L X MIN

REF.:
024470001

LAVAPLATOS SENCILLO

ALUVIA TRICETA	MANIJA	PICO	CARTUCHO	AIREADOR
				
REF.: AV5040001 AV5020001 AV5043331	REF.: 024750001  025135551	REF.: 024980001	REF.: 024790001	REF.: 024470001





ATHENEA	MANIJA	PICO	CARTUCHO	AIREADOR
				
REF.: 415185551	REF.: 021270001	REF.: 024980001	REF.: 019090001	REF.: 024470001







NOGAL	MANIJA	PICO	CARTUCHO	AIREADOR
				
REF.: 455075551	REF.:  025185551	REF.: 034010001	REF.: 014680001  014685551	REF.: 024460001







SEVILLA	MANIJA	PICO	CARTUCHO	AIREADOR
				
REF.: CV5020001	REF.: 021300001	REF.: 034010001	REF.: 014680001  014685551	REF.: 024460001

LAVAPLATOS SENCILLO

MONACO	MANIJA	PICO	CARTUCHO	AIREADOR
				
REF.: MC5020001	REF.: 021250001	REF.: 034010001	REF.: 014680001  014685551	REF.: 024460001

BRIZA	MANIJA	PICO	CARTUCHO	AIREADOR
				
REF.: 545080001	REF.: 025070001	REF.: 034010001	REF.: 014680001  014685551	REF.: 024460001

ARTESA	MANIJA	PICO	CARTUCHO	AIREADOR
				
REF.: 505050001	REF.: 024770001  025195551	REF.: 034010001	REF.: 014680001  014685551	REF.: 024460001

FONTANA MANIJA GALAXIA	MANIJA	PICO	CARTUCHO	AIREADOR
				
REF.: 517000001	REF.: 024770001  025195551	REF.: 034010001	REF.: 014680001  014685551	REF.: 024460001

LAVAPLATOS DE PARED

BALTA PALANCA



REF.:
415110001

MANIJA



MANIJA BALTA
PALANCA

REF.:
021290001

PICO



NARIZ TUBULAR
PLÁSTICA

REF.:
034010001

CARTUCHO



UNIDAD CERÁMICA
DERECHA CORTO

REF.:
014680001
🏠 014685551

AIREADOR



AIREADOR HEMBRA 5.7
L X MIN

REF.:
024460001

BALTA CRUCETA



REF.:
545050001

MANIJA



MANIJA BALTA
CRUCETA

REF.:
021250001

PICO



NARIZ TUBULAR
PLÁSTICA

REF.:
034010001

CARTUCHO



UNIDAD CERÁMICA
DERECHA CORTO

REF.:
014680001
🏠 014685551

AIREADOR



AIREADOR HEMBRA 5.7
L X MIN

REF.:
024460001

CONTENIDO

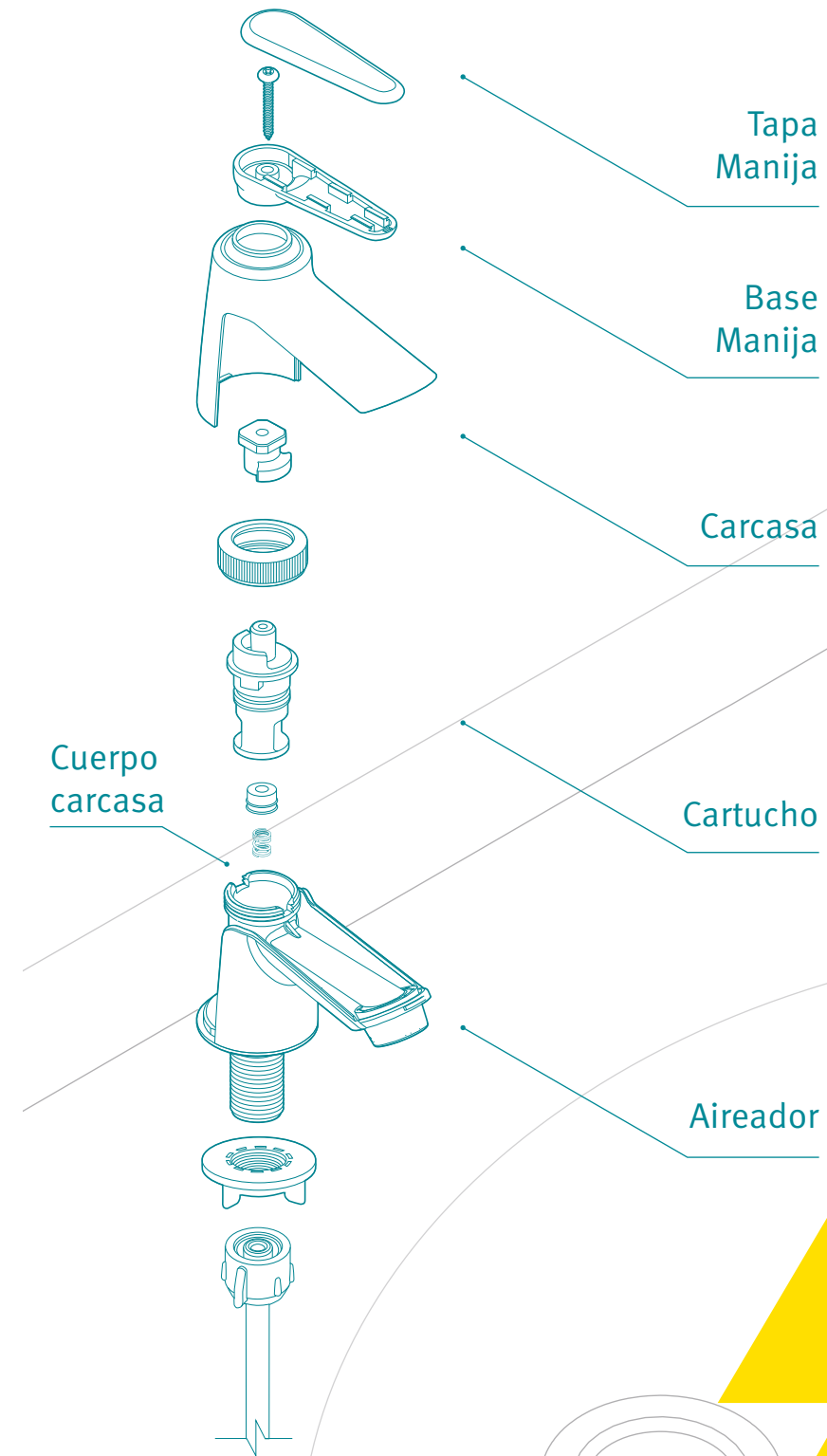

GRIFERÍAS DE
LAVAMANOS

LAVAMANOS SENCILLO

BRIZA	MANIJA	CARTUCHO
		
REF: 321535551 321545551 321493331	REF: 025060001	REF: 019090001

TAMARA	MANIJA	CARTUCHO
		
REF: 631125551 631070001 631073331	REF: 024780001  025205551	REF: 019090001

ARTESA	MANIJA	CARTUCHO
		
REF: AE1000001 AE1030001 AE1003331	REF: 024780001  025205551	REF: 019090001

DALIA	MANIJA	CARTUCHO
		
REF: 431135551 431150001 431123331	REF: 021300001	REF: 019090001

LAVAMANOS SENCILLO

BALTA CRUCETA	MANIJA	CARTUCHO
		
REF: 411230001 411220001 411233331	REF: 021270001	REF: 019090001

BALTA PALANCA	MANIJA	CARTUCHO
		
REF: 411250001 411240001 411253331	REF: 021300001	REF: 019090001

NOGAL	MANIJA	CARTUCHO
		
REF: 541135551 541130001 541133331	REF: 025175551	REF: 019090001

ARCE	MANIJA	CARTUCHO
		
REF: CP1010001 CP1020001	REF: 021300001	REF: 019090001

LAVAMANOS SENCILLO

ROBLE

MANIJA

CARTUCHO



REF.:
OR1110001
OR1120001



MANIJA BALTA
CRUCETA

REF.:
O21270001



UNIDAD CIERRE 90 AST. PLÁSTICA

REF.:
O19090001

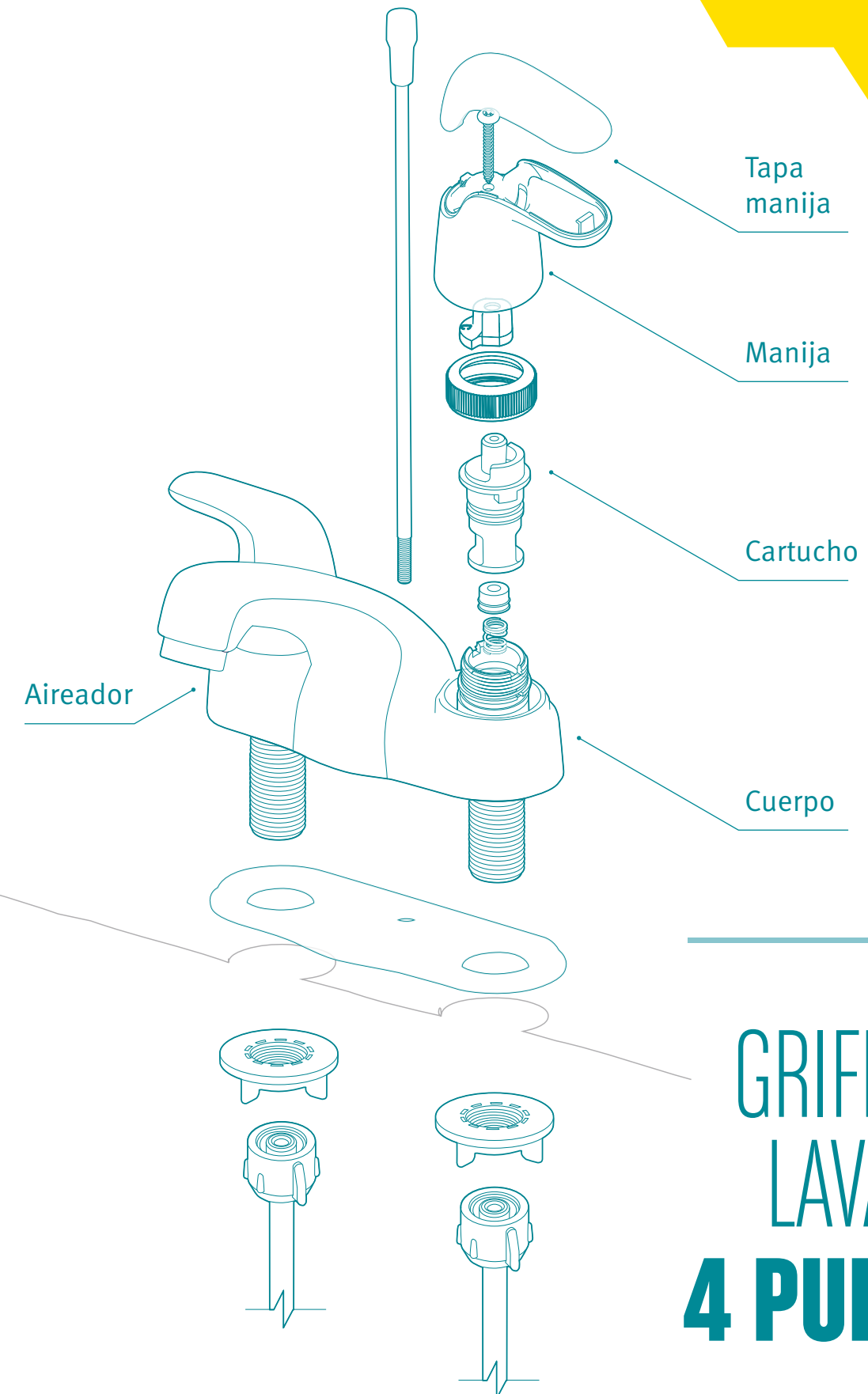

GRIFERÍAS DE
LAVAMANOS
4 PULGADAS

LAVAMANOS 4 PULGADAS

BRIZA	MANIJA	CARTUCHO	AIREADOR
			
REF: 32155551 32156551 32151331	REF: 025060001	REF: 010720001  010725551	REF: 024460001

TAMARA	MANIJA	CARTUCHO	AIREADOR
			
REF: 63113551	REF: 024780001  02520551	REF: 010720001  010725551	REF: 024460001







ARTESA	MANIJA	CARTUCHO	AIREADOR
			
REF: AE1060001 AE1070001 AE1013331	REF: 024780001  02520551	REF: 010720001  010725551	REF: 024460001

DALIA	MANIJA	CARTUCHO	AIREADOR
			
REF: 431180001 431190001 431103331	REF: 024710001  02518551	REF: 010720001  010725551	REF: 024460001

LAVAMANOS 4 PULGADAS

NOGAL	MANIJA	CARTUCHO	AIREADOR
			
REF: 541145551 541140001	REF: 024710001  02518551	REF: 010720001  010725551	REF: 024460001

ALUVIA TRICETA	MANIJA	CARTUCHO	AIREADOR
			
REF: AV1040001 AV1020001 AV1043331	REF: 024750001  02513551	REF: 010720001  010725551	REF: 024460001

ALUVIA PALANCA	MANIJA	CARTUCHO	AIREADOR
			
REF: AV1030001 AV1010001 AV1033331	REF: 024730001  02512551	REF: 010720001  010725551	REF: 024460001

BALTA CRUCETA	MANIJA	CARTUCHO	AIREADOR
			
REF: 411130001 411120001 411133331	REF: 021270001	REF: 010720001  010725551	REF: 024460001

LAVAMANOS 4 PULGADAS

BALTA PALANCA

MANIJA

CARTUCHO

AIREADOR



MANIJA BALTA PALANCA

UNIDAD CIERRE 90 AST. PLÁSTICA

AIREADOR HEMBRA

REF.:
411170001
411173331

REF.:
021300001

REF.:
010720001
010725551

REF.:
024460001

ROBLE

MANIJA

CARTUCHO

AIREADOR



MANIJA BALTA CRUCETA

UNIDAD CIERRE 90 AST. PLÁSTICA

AIREADOR HEMBRA

REF.:
OR1020001

REF.:
021270001

REF.:
010720001
010725551

REF.:
024460001

ARCE

MANIJA

CARTUCHO

AIREADOR



MANIJA NOGAL

UNIDAD CIERRE 90 AST. PLÁSTICA

AIREADOR HEMBRA

REF.:
CP1120001

REF.:
024710001
025185551

REF.:
010720001
010725551

REF.:
024460001

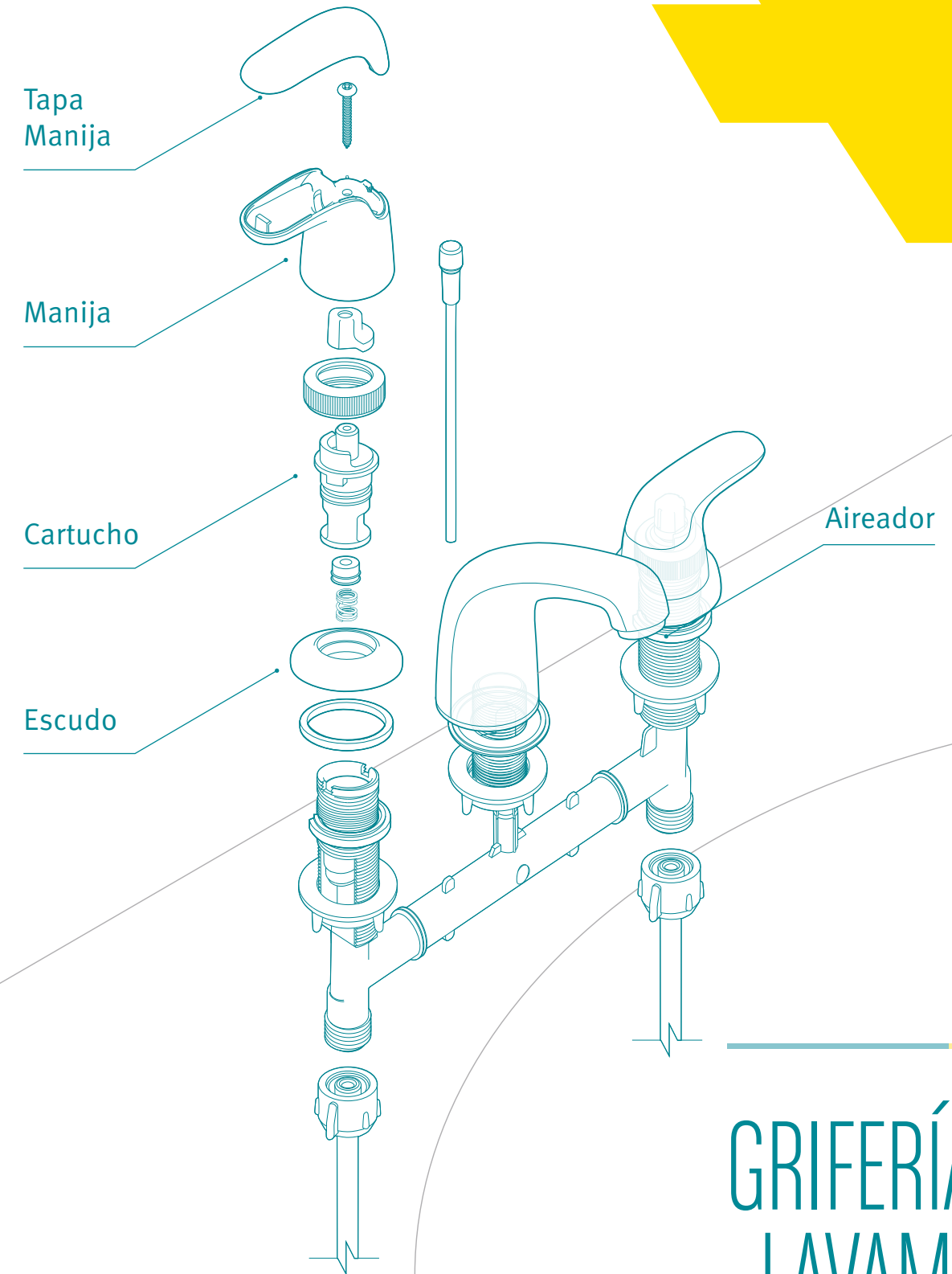

GRIFERÍAS DE LAVAMANOS 8 PULGADAS

LAVAMANOS 8 PULGADAS

BRIZA



REF.:
321575551
321585551
321403331

MANIJA



MANIJA BRIZA

REF.:
O25060001

CARTUCHO



UNIDAD CIERRE 90 AST.
PLÁSTICA

REF.:
O10720001

AIREADOR



AIREADOR HEMBRA

REF.:
O24460001

ARTESA



REF.:
AE1040001
AE1023331

MANIJA



MANIJA ARTESA

REF.:
O24780001
O25205551

CARTUCHO



UNIDAD CIERRE 90 AST.
PLÁSTICA

REF.:
O19090001

AIREADOR



AIREADOR HEMBRA

REF.:
O24460001

DALIA PLUS



REF.:
431160001
431170001
431113331

MANIJA



MANIJA NOGAL

REF.:
O24710001
O25185551

CARTUCHO



UNIDAD CIERRE 90 AST.
PLÁSTICA

REF.:
O19090001

AIREADOR



AIREADOR HEMBRA

REF.:
O24460001

NOGAL



REF.:
541155551
541150001

MANIJA



MANIJA NOGAL

REF.:
O24710001
O25185551

CARTUCHO



UNIDAD CIERRE 90 AST.
PLÁSTICA

REF.:
O19090001

AIREADOR



AIREADOR HEMBRA

REF.:
O24460001

LAVAMANOS 8 PULGADAS

BALTA PALANCA



REF.:
411210001
411200001
411193331

MANIJA



MANIJA BALTA
PALANCA

REF.:
O21300001

CARTUCHO



UNIDAD CIERRE 90 AST.
PLÁSTICA

REF.:
O19090001

AIREADOR



AIREADOR HEMBRA

REF.:
O24460001

BALTA CRUCETA



REF.:
411190001
411200001
411213331

MANIJA



MANIJA BALTA
CRUCETA

REF.:
O21270001

CARTUCHO



UNIDAD CIERRE 90 AST.
PLÁSTICA

REF.:
O19090001

AIREADOR



AIREADOR HEMBRA

REF.:
O24460001

ALUVIA TRICETA



REF.:
AV1080001
AV1060001

MANIJA



MANIJA ALUVIA
TRICETA

REF.:
O24750001
O25135551

CARTUCHO



UNIDAD CIERRE 90 AST.
PLÁSTICA

REF.:
O19090001

AIREADOR



AIREADOR HEMBRA

REF.:
O24460001

ALUVIA PALANCA



REF.:
AV1070001
AV1050001

MANIJA



MANIJA ALUVIA
PALANCA

REF.:
O24730001
O25125551

CARTUCHO



UNIDAD CIERRE 90 AST.
PLÁSTICA

REF.:
O19090001

AIREADOR



AIREADOR HEMBRA

REF.:
O24460001

LAVAMANOS 8 PULGADAS

ROBLE



REF.:
OR1210001
OR1200001

MANIJA



MANIJA BALTA
CRUCETA

REF.:
021270001

CARTUCHO



UNIDAD CIERRE 90
AST. PLÁSTICA

REF.:
019090001

AIREADOR



AIREADOR HEMBRA

REF.:
024460001

ARCE



REF.:
CP1220001

MANIJA



MANIJA NOGAL

REF.:
024710001
025185551

CARTUCHO



UNIDAD CIERRE 90
AST. PLÁSTICA

REF.:
019090001

AIREADOR



AIREADOR HEMBRA

REF.:
024460001

LIQUID



REF.:
LQ1020001

MANIJA

CARTUCHO



UNIDAD CERÁMICA
CORTO

REF.:
014680001 DER.
014690001 IZQ.
014685551 DER.
014695551 IZQ.

AIREADOR

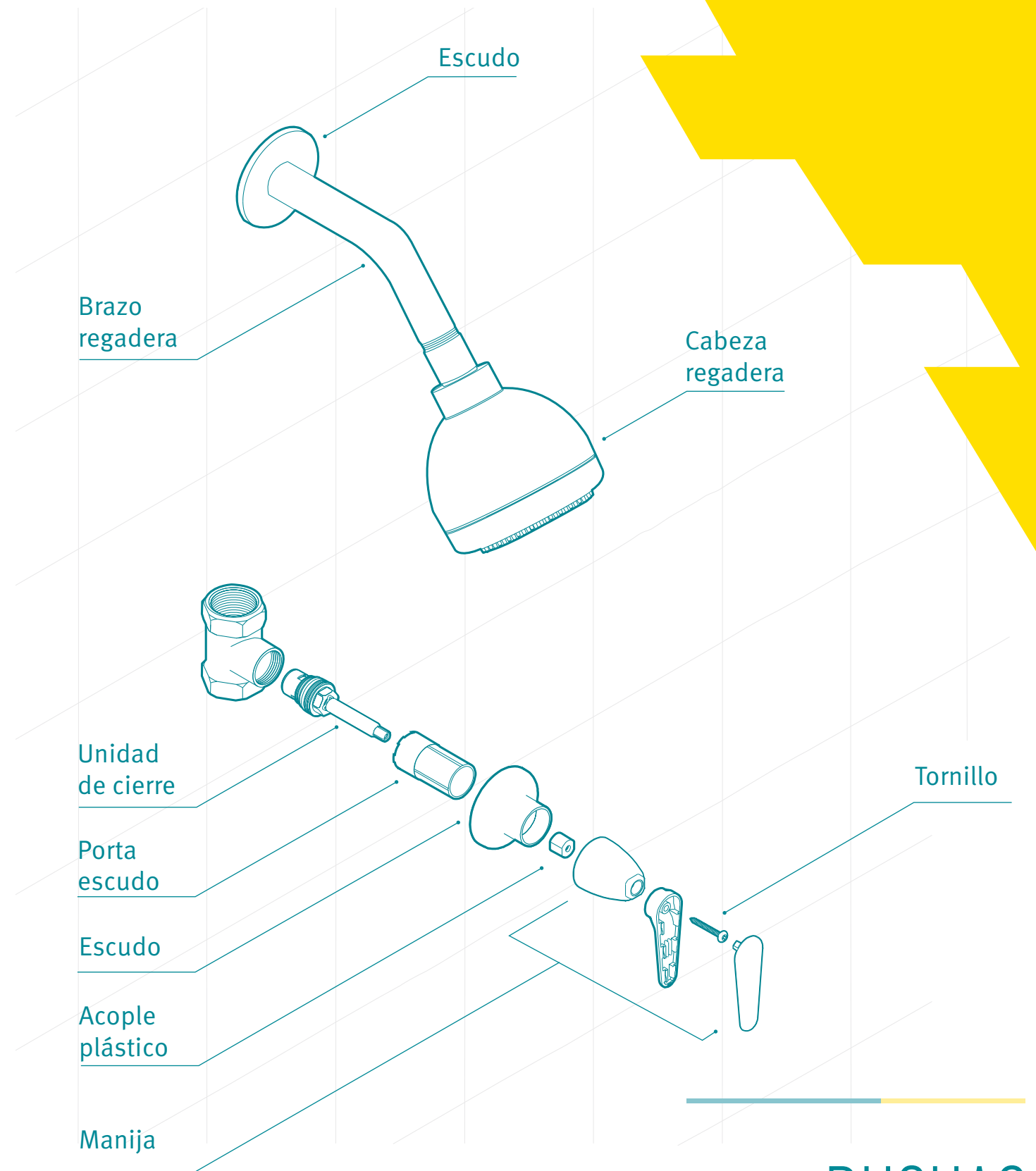

DUCHAS SENCILLAS

DUCHAS SENCILLAS

BRIZA FUNCIONAL	REGADERA	MANIJA	CARTUCHO	ESCUDO	BRAZO
					
REF.: 324615551 324603331	REF.: 924800001	REF.: 025070001	REF.: 014700001  014705551	REF.: 013530001  022125551	REF.: 924060001

TAMARA FUNCIONAL	REGADERA	MANIJA	CARTUCHO	ESCUDO	BRAZO
					
REF.: 634115551 634093331	REF.: 924800001	REF.: 024780004  025195551	REF.: 014700001  014705551	REF.: 013530001  022125551	REF.: 924060001

BRIZA PLUS	REGADERA	MANIJA	CARTUCHO	ESCUDO	BRAZO
					
REF.: 544355551	REF.: RA4015551	REF.: 025070001	REF.: 014700001  014705551	REF.: 013530001  022125551	REF.: 924060001

ARTESA PRO	REGADERA	MANIJA	CARTUCHO	ESCUDO	BRAZO
					
REF.: AE4095551 AE4030001	REF.: 924800001	REF.: 024780004  025195551	REF.: 014700001  014705551	REF.: 013530001  022125551	REF.: 924060001

DUCHAS SENCILLAS

DALIA PRO	REGADERA	MANIJA	CARTUCHO	ESCUDO	BRAZO
					
REF.: DL4065551 DL4063331	REF.: 924800001	REF.: 024720001  025185551	REF.: 014700001  014705551	REF.: 013530001  022125551	REF.: 924060001

BALTA CRUCETA RIVA	REGADERA	MANIJA	CARTUCHO	ESCUDO	BRAZO
					
REF.: 414513331	REF.: RA4015551	REF.: 021250001	REF.: 014700001  014705551	REF.: 013530001  022125551	REF.: 924060001

BALTA PALANCA RIVA	REGADERA	MANIJA	CARTUCHO	ESCUDO	BRAZO
					
REF.: 414533331	REF.: 924800001	REF.: 024720001  025185551	REF.: 014700001  014705551	REF.: 013530001  022125551	REF.: 924060001

NOGAL COSMOS	REGADERA	MANIJA	CARTUCHO	ESCUDO	BRAZO
					
REF.: 434350001 434353331	REF.: RA4015551	REF.: 024720001  025185551	REF.: 014700001  014705551	REF.: 013530001  022125551	REF.: 924060001

DUCHAS SENCILLAS

BALTA IMPERIAL REDONDA	REGADERA	MANIJA	CARTUCHO	ESCUDO	BRAZO
REF.: 414140001	REF.: IP4015551	REF.: 024720001 025185551	REF.: 014700001 014705551	REF.: 013530001 022125551	REF.: 924060001

BALTA IMPERIAL REDONDA	REGADERA	MANIJA	CARTUCHO	ESCUDO	BRAZO
REF.: 414130001	REF.: IP4015551	REF.: 021250001	REF.: 014700001 014705551	REF.: 013530001 022125551	REF.: 924060001

ALUVIA PALANCA IMPERIAL	REGADERA	MANIJA	CARTUCHO	ESCUDO	BRAZO
REF.: AV4050001 AV4053331	REF.: IP4015551	REF.: 024740001 025125551	REF.: 014700001 014705551	REF.: 013530001 022125551	REF.: 924060001

ALUVIA TRICETA IMPERIAL	REGADERA	MANIJA	CARTUCHO	ESCUDO	BRAZO
REF.: AV4060001 AV4063331	REF.: IP4015551	REF.: 024760001 025135551	REF.: 014700001 014705551	REF.: 013530001 022125551	REF.: 924060001

DUCHAS SENCILLAS

BALTA IMPERIAL CUADRADA	REGADERA	MANIJA	CARTUCHO	ESCUDO	BRAZO
REF.: BL4030001	REF.: IP4015551	REF.: 021290001	REF.: 014700001 014705551	REF.: 013530001 022125551	REF.: 924060001

BALTA IMPERIAL CUADRADA	REGADERA	MANIJA	CARTUCHO	ESCUDO	BRAZO
REF.: BL4020001	REF.: IP4015551	REF.: 021250001	REF.: 014700001 014705551	REF.: 013530001 022125551	REF.: 924060001

ROBLE KORAL	REGADERA	MANIJA	CARTUCHO	ESCUDO	BRAZO
REF.: OR4175551	REF.: KR4065551	REF.: 021250001	REF.: 014700001 014705551	REF.: 013530001 022125551	REF.: 924060001

ARCE KORAL	REGADERA	MANIJA	CARTUCHO	ESCUDO	BRAZO
REF.: RC4035551	REF.: KR4065551	REF.: 024720001 025185551	REF.: 014700001 014705551	REF.: 013530001 022125551	REF.: 924060001

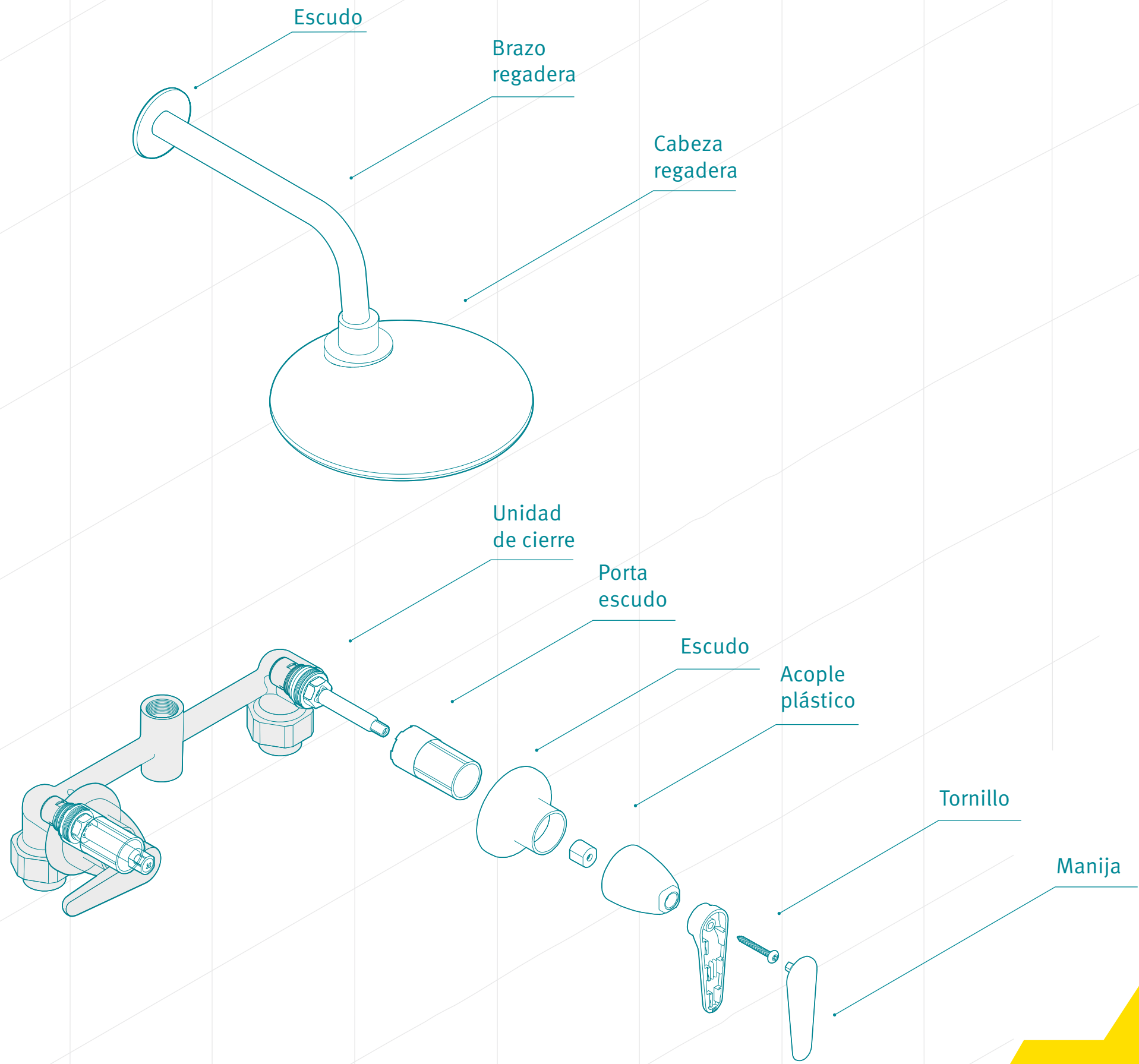

DUCHAS
8 PULGADAS

DUCHAS 8 PULGADAS

BRIZA	REGADERA	MANIJA	CARTUCHO	ESCUDO	BRAZO
					
REF.: 324625551 324503331	REGADERA FUNCIONAL REF.: 924800001	MANIJA BRIZA REF.: 025070001	UNIDAD CERÁMICA LARGA REF.: 014700001 DER. 014710001 IZQ.  014705551 DER.  014715551 IZQ.	ESCUDO REF.: 013530001  022125551	BRAZO REGADERA MEDIANO REF.: 924060001

TAMARA	REGADERA	MANIJA	CARTUCHO	ESCUDO	BRAZO
					
REF.: 634125551 634103331	REGADERA FUNCIONAL REF.: 924800001	MANIJA ARTESA REF.: 024780004  025195551	UNIDAD CERÁMICA LARGA REF.: 014700001 DER. 014710001 IZQ.  014705551 DER.  014715551 IZQ.	ESCUDO REF.: 013530001  022125551	BRAZO REGADERA MEDIANO REF.: 924060001

BRIZA PLUS	REGADERA	MANIJA	CARTUCHO	ESCUDO	BRAZO
					
REF.: 544245551	REGADERA RIVA REF.: RA4015551	MANIJA BRIZA REF.: 025070001	UNIDAD CERÁMICA LARGA REF.: 014700001 DER. 014710001 IZQ.  014705551 DER.  014715551 IZQ.	ESCUDO REF.: 013530001  022125551	BRAZO REGADERA MEDIANO REF.: 924060001

ARTESA PRO	REGADERA	MANIJA	CARTUCHO	ESCUDO	BRAZO
					
REF.: AE4085551 AE4083331	REGADERA DALIA REF.: DL4045551	MANIJA ARTESA REF.: 024780004  025195551	UNIDAD CERÁMICA LARGA REF.: 014700001 DER. 014710001 IZQ.  014705551 DER.  014715551 IZQ.	ESCUDO REF.: 013530001  022125551	BRAZO REGADERA MEDIANO REF.: 924060001

DUCHAS 8 PULGADAS

DALIA PRO	REGADERA	MANIJA	CARTUCHO	ESCUDO	BRAZO
					
REF.: DL4055551 DL4053331	REGADERA DALIA REF.: DL4045551	MANIJA NOGAL REF.: 024720001  025185551	UNIDAD CERÁMICA DERECHA LARGA REF.: 014700001 DER. 014710001 IZQ.  014705551 DER.  014715551 IZQ.	ESCUDO REF.: 013530001  022125551	BRAZO REGADERA MEDIANO REF.: 924060001





BALTA PALANCA RIVA	REGADERA	MANIJA	CARTUCHO	ESCUDO	BRAZO
					
REF.: 414503331	REGADERA RIVA REF.: RA4015551	MANIJA BALTA PALANCA REF.: 021290001	UNIDAD CERÁMICA DERECHA LARGA REF.: 014700001 DER. 014710001 IZQ.  014705551 DER.  014715551 IZQ.	ESCUDO REF.: 013530001  022125551	BRAZO REGADERA MEDIANO REF.: 924060001

BALTA CRUCETA RIVA	REGADERA	MANIJA	CARTUCHO	ESCUDO	BRAZO
					
REF.: 414523331	REGADERA RIVA REF.: RA4015551	MANIJA BALTA CRUCETA REF.: 021250001	UNIDAD CERÁMICA DERECHA LARGA REF.: 014700001 DER. 014710001 IZQ.  014705551 DER.  014715551 IZQ.	ESCUDO REF.: 013530001  022125551	BRAZO REGADERA MEDIANO REF.: 924060001



NOGAL COSMOS	REGADERA	MANIJA	CARTUCHO	ESCUDO	BRAZO
					
REF.: 434360001 434363331	REGADERA COSMOS REF.: CS4005551	MANIJA NOGAL REF.: 024720001  025185551	UNIDAD CERÁMICA DERECHA LARGA REF.: 014700001 DER. 014710001 IZQ.  014705551 DER.  014715551 IZQ.	ESCUDO REF.: 013530001  022125551	BRAZO REGADERA MEDIANO REF.: 924060001

DUCHAS 8 PULGADAS





NOGAL PAVIA

REGADERA	MANIJA	CARTUCHO	ESCUDO	BRAZO
				
REGADERA KORAL	MANIJA NOGAL	UNIDAD CERÁMICA LARGA	ESCUDO	BRAZO REGADERA MEDIANO
REF.: KR4065551	REF.: O24720001 🏠 O25185551	REF.: O14700001 DER. O14710001 IZQ. 🏠 O14705551 DER. 🏠 O14715551 IZQ.	REF.: O13530001 🏠 O22125551	REF.: 924060001





ALUVIA PALANCA IMPERIAL

REGADERA	MANIJA	CARTUCHO	ESCUDO	BRAZO
				
REGADERA IMPERIAL	MANIJA ALUVIA PALANCA	UNIDAD CERÁMICA LARGA	ESCUDO	BRAZO REGADERA MEDIANO
REF.: AV4010001 AV4013331	REF.: IP4015551 🏠 O25125551	REF.: O24740001 O14700001 DER. O14710001 IZQ. 🏠 O14705551 DER. 🏠 O14715551 IZQ.	REF.: O13530001 🏠 O22125551	REF.: 924060001

ALUVIA TRICETA IMPERIAL

REGADERA	MANIJA	CARTUCHO	ESCUDO	BRAZO
				
REGADERA IMPERIAL	MANIJA ALUVIA TRICETA	UNIDAD CERÁMICA LARGA	ESCUDO	BRAZO REGADERA MEDIANO
REF.: AV4020001 AV4023331	REF.: IP4015551 🏠 O25135551	REF.: O24760001 O14700001 DER. O14710001 IZQ. 🏠 O14705551 DER. 🏠 O14715551 IZQ.	REF.: O13530001 🏠 O22125551	REF.: 924060001

BALTA PALANCA IMPERIAL

REGADERA	MANIJA	CARTUCHO	ESCUDO	BRAZO
				
REGADERA IMPERIAL	MANIJA NOGAL	UNIDAD CERÁMICA LARGA	ESCUDO	BRAZO REGADERA MEDIANO
REF.: 414110001	REF.: IP4015551 🏠 O25185551	REF.: O24720001 O14700001 DER. O14710001 IZQ. 🏠 O14705551 DER. 🏠 O14715551 IZQ.	REF.: O13530001 🏠 O22125551	REF.: 924060001

DUCHAS 8 PULGADAS





BALTA CRUCETA IMPERIAL

REGADERA	MANIJA	CARTUCHO	ESCUDO	BRAZO
				
REGADERA IMPERIAL	MANIJA BALTA CRUCETA	UNIDAD CERÁMICA LARGA	ESCUDO	BRAZO REGADERA MEDIANO
REF.: 414120001	REF.: IP4015551 O21250001	REF.: O14700001 DER. O14710001 IZQ. 🏠 O14705551 DER. 🏠 O14715551 IZQ.	REF.: O13530001 🏠 O22125551	REF.: 924060001

CASCADE IMPERIAL

REGADERA	MANIJA	CARTUCHO	ESCUDO	BRAZO
				
REGADERA IMPERIAL	MANIJA CASCADE	UNIDAD CERÁMICA LARGA	ESCUDO	BRAZO REGADERA MEDIANO
REF.: CA4005551	REF.: IP4015551 O24700001	REF.: O14700001 DER. O14710001 IZQ. 🏠 O14705551 DER. 🏠 O14715551 IZQ.	REF.: O13530001 🏠 O22125551	REF.: 924060001

ARCE KORAL

REGADERA	MANIJA	CARTUCHO	ESCUDO	BRAZO
				
REGADERA KORAL	MANIJA NOGAL	UNIDAD CERÁMICA LARGA	ESCUDO	BRAZO REGADERA MEDIANO
REF.: RC4025551	REF.: KR4065551 🏠 O25185551	REF.: O24720001 O14700001 DER. O14710001 IZQ. 🏠 O14705551 DER. 🏠 O14715551 IZQ.	REF.: O13530001 🏠 O22125551	REF.: 924060001



ROBLE KORAL

REGADERA	MANIJA	CARTUCHO	ESCUDO	BRAZO
				
REGADERA KORAL	MANIJA BALTA CRUCETA	UNIDAD CERÁMICA LARGA	ESCUDO	BRAZO REGADERA MEDIANO
REF.: OR4165551	REF.: KR4065551 O21250001	REF.: O14700001 DER. O14710001 IZQ. 🏠 O14705551 DER. 🏠 O14715551 IZQ.	REF.: O13530001 🏠 O22125551	REF.: 924060001

DUCHAS 8 PULGADAS

LIQUID	REGADERA	MANIJA	CARTUCHO	ESCUDO	BRAZO
 REF.: LQ405551	 REGADERA LIQUID REF.: LQ4010001	 MANIJA LIQUID REF.: 4000004507 EXCLUSIVO PSA	 UNIDAD CERÁMICA LARGA REF.: O14700001 DER. O14710001 IZQ. O14705551 DER. O14715551 IZQ.	 ESCUDO REF.: O13530001 O22125551	 BRAZO IRON LARGO REF.: IR4005551

VAAL	REGADERA	MANIJA	CARTUCHO	ESCUDO	BRAZO
 REF.: VV4005551	 REGADERA KORAL REF.: KR4065551	 MANIJA VAAL REF.: 40000003272 EXCLUSIVO PSA	 UNIDAD CERÁMICA LARGA REF.: O14700001 DER. O14710001 IZQ. O14705551 DER. O14715551 IZQ.	 ESCUDO REF.: O13530001 O22125551	 BRAZO IRON LARGO REF.: IR4005551





DRAA	REGADERA	MANIJA	CARTUCHO	ESCUDO	BRAZO
 REF.: DR4015551	 DRAA 8 PULGADAS REF.: DR4045551				 BRAZO IRON LARGO REF.: IR4005551

LAVAPLATOS DESCONTINUADOS

PISCIS 8 PULGADAS	MANIJA	PICO	CARTUCHO	AIREADOR
 REF.: 545100001 545600001	 MANIJA BRIZA REF.: O25060001	 NARIZ TUBULAR PLÁSTICA REF.: O34010001	 UNIDAD CIERRE 90 AST. PLÁSTICA REF.: O19090001	 AIREADOR HEMBRA 5.7 LX MIN REF.: O24460001

GALAXIA 8 PULGADAS	MANIJA	PICO	CARTUCHO	AIREADOR
 REF.: 505100001	 MANIJA ARTESA REF.: 24780001 O25205551	 NARIZ TUBULAR PLÁSTICA REF.: O34010001	 UNIDAD CIERRE 90 AST. PLÁSTICA REF.: O19090001	 AIREADOR HEMBRA 5.7 LX MIN REF.: O24460001

AQUA 8 PULGADAS	MANIJA	PICO	CARTUCHO	AIREADOR
 REF.: 545806661	 MANIJA BRIZA REF.: O25060001	 NARIZ TUBULAR PLÁSTICA REF.: O34010001	 UNIDAD CIERRE 90 AST. PLÁSTICA REF.: O19090001	

PISCIS 8 PULGADAS	MANIJA	PICO	CARTUCHO	AIREADOR
 REF.: 545050001 545060001 545153331	 MANIJA GALAXIA REF.: O12395551 O13355551	 NARIZ TUBULAR PLÁSTICA REF.: O34010001	 UNIDAD CIERRE 90 AST. PLÁSTICA REF.: O19090001	 AIREADOR HEMBRA 5.7 LX MIN REF.: O24460001

LAVAPLATOS DESCONTINUADOS

GALAXIA 8 PULGADAS

	MANIJA	PICO	CARTUCHO	AIREADOR
				
REF.: 505500001 509500001	REF.: 24780001  02520551	REF.: 034010001	REF.: 019090001	REF.: 024460001

HERA 8 PULGADAS

	MANIJA	PICO	CARTUCHO	AIREADOR
				
REF.: HE5005551	REF.: 024710001  02518551	REF.: 034010001	REF.: 019090001	REF.: 024460001

BURDEOS 8 PULGADAS

	MANIJA	PICO	CARTUCHO	AIREADOR
				
REF.: 585095551	REF.: 024710001  02518551	REF.: 024970001	REF.: 019090001	REF.: 024460001

PISCIS SENCILLA

	MANIJA	PICO	CARTUCHO	AIREADOR
				
REF.: 545200001 549600001	REF.: 025060001	REF.: 034010001	REF.: 019090001	REF.: 024460001

LAVAPLATOS DESCONTINUADOS

RIO SENCILLA

	MANIJA	PICO	CARTUCHO	AIREADOR
				
REF.: 545950001 545956661	REF.: 025060001	REF.: 034010001	REF.: 019090001	

PISCIS SENCILLA

	MANIJA	PICO	CARTUCHO	AIREADOR
				
REF.: 545030001 545040001 545163331	REF.: 025060001	REF.: 034010001	REF.: 019090001	REF.: 024460001

GALAXIA PB SENCILLA

	MANIJA	PICO	CARTUCHO	AIREADOR
				
REF.: 505000001 509600001	REF.: 24780001  02520551	REF.: 034010001	REF.: 019090001	

GALAXIA PP SENCILLA





	MANIJA	PICO	CARTUCHO	AIREADOR
				
REF.: 505070001 505080001	REF.: 24780001  02520551	REF.: 034010001	REF.: 019090001	REF.: 024460001

LAVAPLATOS DESCONTINUADOS

MARRUECOS SENCILLA

	MANIJA	PICO	CARTUCHO	AIREADOR
				
REF.: 795300001	MANIJA BALTA CRUCETA REF.: 021250001	NARIZ TUBULAR PLÁSTICA REF.: 034010001	UNIDAD CERÁMICA DERECHA CORTO REF.: 014680001  014685551	AIREADOR MACHO 5.7 L X MIN REF.: 024470001





MARRUECOS DE PARED

	MANIJA	PICO	CARTUCHO	AIREADOR
				
REF.: 795280001	MANIJA BALTA CRUCETA REF.: 021250001		UNIDAD CERÁMICA DERECHA CORTO REF.: 014680001  014685551	AIREADOR HEMBRA 5.7 L X MIN REF.: 024460001

MARRUECOS DE PARED

	MANIJA	PICO	CARTUCHO	AIREADOR
				
REF.: 795310001	MANIJA BALTA CRUCETA REF.: 021250001			AIREADOR HEMBRA 5.7 L X MIN REF.: 024460001

GALAXIA DE PARED

	MANIJA	PICO	CARTUCHO	AIREADOR
				
REF.: 505190001	MANIJA ARTESA REF.: 24780001  025205551		UNIDAD CERÁMICA DERECHA CORTO REF.: 014680001  014685551	AIREADOR HEMBRA 5.7 L X MIN REF.: 024460001

LAVAMANOS DESCONTINUADOS

PISCIS SENCILLA

	MANIJA	CARTUCHO
		
REF.: 541390001 541490001	MANIJA BRIZA REF.: 025060001	UNIDAD CIERRE 90 AST.PLÁSTICA REF.: 019090001

FENIX SENCILLA

	MANIJA	CARTUCHO
		
REF.: 581490001	MANIJA NOGAL REF.: 024710001  025185551	UNIDAD CIERRE 90 AST.PLÁSTICA REF.: 019090001

ATHENEA SENCILLA

	MANIJA	CARTUCHO
		
REF.: 411285551	MANIJA BALTA CRUCETA REF.: 021250001	UNIDAD CIERRE 90 AST.PLÁSTICA REF.: 019090001

MARRUECOS SENCILLA

	MANIJA	CARTUCHO
		
REF.: 581490001	MANIJA BALTA CRUCETA REF.: 021250001	UNIDAD CIERRE 90 AST.PLÁSTICA REF.: 019090001

LAVAMANOS DESCONTINUADOS



PISCIS 4 PULGADAS

	MANIJA	CARTUCHO	AIREADOR
			
REF.: 541300001	MANIJA BRIZA REF.: 025060001	UNIDAD CIERRE 90 AST. PLÁSTICA REF.: 019090001	AIREADOR HEMBRA 5.7 LX MIN REF.: 024460001

MARRUECOS 4 PULGADAS

	MANIJA	CARTUCHO	AIREADOR
			
REF.: 791300001	MANIJA BRIZA REF.: 025060001	UNIDAD CERÁMICA DERECHA CORTO REF.: 014680001 DER. 014690001 IZQ.  014685551 DER.  014695551 IZQ.	AIREADOR HEMBRA 5.7 LX MIN REF.: 024460001

PISCIS 8 PULGADAS

	MANIJA	CARTUCHO	AIREADOR
			
		UNIDAD CIERRE 90 AST. PLÁSTICA REF.: 019090001	AIREADOR HEMBRA 5.7 LX MIN REF.: 024460001

DUCHAS DESCONTINUADOS

RIO FUNCIONAL

	REGADERA	MANIJA	CARTUCHO	ESCUDO	BRAZO
					
REF.: 544956661	REGADERA FUNCIONAL REF.: 924800001	MANIJA BRIZA REF.: 025060001	UNIDAD CIERRE 90 AST. PLÁSTICA REF.: 019090001	ESCUDO REF.: 013530001  022125551	BRAZO REGADERA MEDIANO REF.: 924060001

PISCIS FUNCIONAL

	REGADERA	MANIJA	CARTUCHO	ESCUDO	BRAZO
					
REF.: 544300001	REGADERA FUNCIONAL REF.: 924800001	MANIJA BRIZA REF.: 025060001	UNIDAD CERÁMICA DERECHA LARGA REF.: 014700001  014705551	ESCUDO REF.: 013530001  022125551	BRAZO REGADERA MEDIANO REF.: 924060001

NOGAL PIANA

	REGADERA	MANIJA	CARTUCHO	ESCUDO	BRAZO
					
REF.: 414315551	REGADERA KORAL REF.: KR4065551	MANIJA NOGAL REF.: 024720001  025185551	UNIDAD CERÁMICA DERECHA LARGA REF.: 014700001  014705551	ESCUDO REF.: 013530001  022125551	BRAZO REGADERA MEDIANO REF.: 924060001

NOGAL CUADRADA

	REGADERA	MANIJA	CARTUCHO	ESCUDO	BRAZO
					
REF.: 434300001	REGADERA IMPERIAL REF.: IP4015551	MANIJA NOGAL REF.: 024720001  025185551	UNIDAD CERÁMICA DERECHA LARGA REF.: 014700001  014705551	ESCUDO REF.: 013530001  022125551	BRAZO REGADERA MEDIANO REF.: 924060001

DUCHAS DESCONTINUADOS

ATHENEA COSMOS	REGADERA	MANIJA	CARTUCHO	ESCUDO	BRAZO
					
REF.: 414285551	REGADERA COSMOS REF.: CS4005551	MANIJA NOGAL REF.: O24720001  O25185551	UNIDAD CERÁMICA DERECHA LARGA REF.: O14700001  O14705551	ESCUDO REF.: O13530001  O22125551	BRAZO REGADERA MEDIANO REF.: 924060001

ARCE REDONDA	REGADERA	MANIJA	CARTUCHO	ESCUDO	BRAZO
					
REF.: CP4020001	REGADERA IMPERIAL REF.: IP4015551	MANIJA NOGAL REF.: O24720001  O25185551	UNIDAD CERÁMICA DERECHA LARGA REF.: O14700001  O14705551	ESCUDO REF.: O13530001  O22125551	BRAZO REGADERA MEDIANO REF.: 924060001

PISCIS SSB 8P	REGADERA	MANIJA	CARTUCHO	ESCUDO	BRAZO
					
REF.: 544100001	REGADERA FUNCIONAL REF.: 924800001	MANIJA BRIZA REF.: O25060001	UNIDAD CERÁMICA DERECHA LARGA REF.: O14700001 DER. O14710001 IZQ.  O14705551 DER.  O14715551 IZQ.	ESCUDO REF.: O13530001  O22125551	BRAZO REGADERA MEDIANO REF.: 924060001

TALORI SSB 8P	REGADERA	MANIJA	CARTUCHO	ESCUDO	BRAZO
					
REF.: 544108881	REGADERA RIVA REF.: RA4015551	MANIJA BRIZA REF.: O25060001	UNIDAD CERÁMICA DERECHA LARGA REF.: O14700001 DER. O14710001 IZQ.  O14705551 DER.  O14715551 IZQ.	ESCUDO REF.: O13530001  O22125551	BRAZO REGADERA MEDIANO REF.: 924060001

DUCHAS DESCONTINUADOS

ROBLE CUADRADA 8P	REGADERA	MANIJA	CARTUCHO	ESCUDO	BRAZO
					
REF.: RB4010001	REGADERA IMPERIAL REF.: IP4015551	MANIJA BALTA CRUCETA REF.: O21250001	UNIDAD CERÁMICA DERECHA LARGA REF.: O14700001 DER. O14710001 IZQ.  O14705551 DER.  O14715551 IZQ.	ESCUDO REF.: O13530001  O22125551	BRAZO REGADERA MEDIANO REF.: 924060001

ROBLE REDONDA 8P	REGADERA	MANIJA	CARTUCHO	ESCUDO	BRAZO
					
REF.: OR4100001	REGADERA IMPERIAL REF.: IP4015551	MANIJA BALTA CRUCETA REF.: O21250001	UNIDAD CERÁMICA DERECHA LARGA REF.: O14700001 DER. O14710001 IZQ.  O14705551 DER.  O14715551 IZQ.	ESCUDO REF.: O13530001  O22125551	BRAZO REGADERA MEDIANO REF.: 924060001

ATHENEA COSMOS 8P	REGADERA	MANIJA	CARTUCHO	ESCUDO	BRAZO
					
REF.: 414265551		MANIJA NOGAL REF.: O24720001  O25185551	UNIDAD CERÁMICA DERECHA LARGA REF.: O14700001 DER. O14710001 IZQ.  O14705551 DER.  O14715551 IZQ.	ESCUDO REF.: O13530001  O22125551	BRAZO REGADERA MEDIANO REF.: 924060001

ARCE REDONDA 8P	REGADERA	MANIJA	CARTUCHO	ESCUDO	BRAZO
					
REF.: CP4110001		MANIJA NOGAL REF.: O24720001  O25185551	UNIDAD CERÁMICA DERECHA LARGA REF.: O14700001 DER. O14710001 IZQ.  O14705551 DER.  O14715551 IZQ.	ESCUDO REF.: O13530001  O22125551	BRAZO REGADERA MEDIANO REF.: 924060001

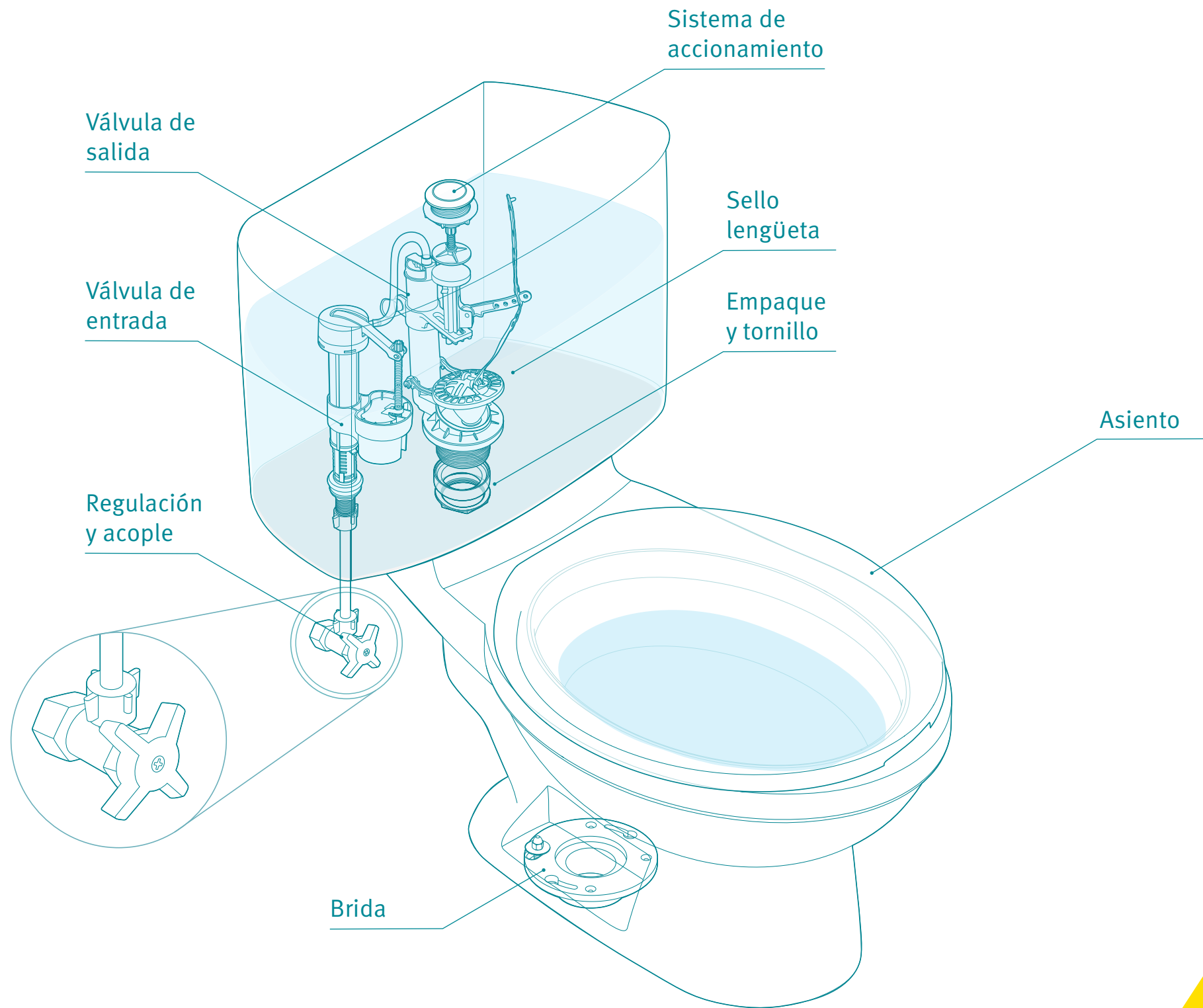

REPUESTOS SANITARIOS

SUGERENCIAS

- Mantener la garantía adquirida con los sanitarios.
- Asegurar el buen desempeño del sanitario y mantener los consumo de agua en óptimo nivel.
- Los repuestos Grival son fabricados bajo estándares de normas técnicas internacionales por lo que podemos asegurar su óptimo funcionamiento.

SANITARIO ACUACER DOS PIEZAS	VÁLVULA DE LLENADO	VÁLVULA DE DESCARGA	ACCIONAMIENTO	GRIFERÍA TANQUE	ASIENTO
					
REF.: 800381000	REF.: 806330001 806333331 806335551	REF.: 806200001 806203331 806205551	REF.: 937500001 937505551	REF.: 806320001 806325551	REF.: 869000001 869003331
COMPATIBLES CON KITS DE INSTALACIÓN  KIT 1  KIT 2					

SANITARIO ACUAPLUS II DOS PIEZAS	VÁLVULA DE LLENADO	VÁLVULA DE DESCARGA	ACCIONAMIENTO	GRIFERÍA TANQUE	ASIENTO
					
REF.: 806330001 806333331 806335551	REF.: 806200001 806203331 806205551	REF.: 025280001	REF.: 818290001	REF.: 869000001 869003331	REF.: 869000001 869003331
COMPATIBLES CON KITS DE INSTALACIÓN  KIT 1  KIT 2					

SANITARIO ACUACER DUAL DOS PIEZAS	VÁLVULA DE LLENADO	VÁLVULA DE DESCARGA	ACCIONAMIENTO	GRIFERÍA TANQUE	ASIENTO
					
REF.: 022850001 022853331 022855551 022856661	REF.: 799310001 816515551	REF.: 021530001 021535551	REF.: 818250001 818255551	REF.: 869000001 869003331	REF.: 869000001 869003331
COMPATIBLES CON KITS DE INSTALACIÓN  KIT 1  KIT 2					

SANITARIO AQUAJET DOS PIEZAS / TAZA ALONGADA	VÁLVULA DE LLENADO	VÁLVULA DE DESCARGA	ACCIONAMIENTO	GRIFERÍA TANQUE	ASIENTO
					
REF.: 026401001	REF.: 806330001 806333331 806335551	REF.: 806200001 806203331 806205551	REF.: 010100001 010105551	REF.: 806320001 806325551	REF.: 839002221
COMPATIBLES CON KITS DE INSTALACIÓN  KIT 1  KIT 2					

SANITARIO ACUACER PLUS DOS PIEZAS	VÁLVULA DE LLENADO	VÁLVULA DE DESCARGA	ACCIONAMIENTO	GRIFERÍA TANQUE	ASIENTO
					
REF.: 320381000	REF.: 806330001 806333331 806335551	REF.: 806200001 806203331 806205551	REF.: 025280001	REF.: 818290001	REF.: 869000001 869003331
COMPATIBLES CON KITS DE INSTALACIÓN  KIT 1  KIT 2					

SANITARIO AQUAPRO DOS PIEZAS / TAZA ALONGADA	VÁLVULA DE LLENADO	VÁLVULA DE DESCARGA	ACCIONAMIENTO	GRIFERÍA TANQUE	ASIENTO
					
REF.: 200401001	REF.: 022850001 022853331 022855551 022856661	REF.: 799310001 816515551	REF.: 024070001 024075551	REF.: 818250001 818255551	REF.: 94908A001
COMPATIBLES CON KITS DE INSTALACIÓN  KIT 2  KIT 3					

SANITARIO AQUAPRO
DOS PIEZAS / TAZA REDONDA

VÁLVULA DE LLENADO	VÁLVULA DE DESCARGA	ACCIONAMIENTO	GRIFERÍA TANQUE	ASIENTO
				
UNIVERSAL PLUS	DUAL AJUSTABLE TWO PIECE 2 PULGADAS	BOTÓN DUAL ALONGADO	KIT DUAL 2 PULGADAS	ASIENTO AQUAPRO REDONDO
REF.: 022850001	REF.: 799310001	REF.: 024070001	REF.: 818250001	REF.: 949080001
022853331	816515551	024075551	818255551	
022855551				
022856661				

REF.: 278431001

COMPATIBLES CON KITS DE INSTALACIÓN

 KIT 2
 KIT 3

SANITARIO ECOCLEAN
SINGLE / DOS PIEZAS / TAZA ALONGADA

VÁLVULA DE LLENADO	VÁLVULA DE DESCARGA	ACCIONAMIENTO	GRIFERÍA TANQUE	ASIENTO
				
UNIVERSAL PLUS	ECOCLEAN	BOTÓN 58 MM		ASIENTO CRESCENTO
REF.: 022850001	REF.: 816610001	REF.: 024940001		REF.: 609471001
022853331		024945551		
022855551				
022856661				

REF.: 026011001

COMPATIBLES CON KITS DE INSTALACIÓN

 KIT 1
 KIT 2

SANITARIO AVANTI PLUS
DOS PIEZAS / TAZA REDONDA

VÁLVULA DE LLENADO	VÁLVULA DE DESCARGA	ACCIONAMIENTO	GRIFERÍA TANQUE	ASIENTO
				
HIDRO PLUS BAJA	NUKI 26 CM	BOTÓN 58 MM + CATAPULTA	KIT DUAL 2 PULGADAS	ASIENTO AERO REDONDO
REF.: 806373331	REF.: 806200001	REF.: 025020001	REF.: 818250001	REF.: 859002221
	806203331		818255551	
	806205551			

COMPATIBLES CON KITS DE INSTALACIÓN

 KIT 1
 KIT 2

SANITARIO GANAMAX
DOS PIEZAS / TAZA ALONGADA

VÁLVULA DE LLENADO	VÁLVULA DE DESCARGA	ACCIONAMIENTO	GRIFERÍA TANQUE	ASIENTO
				
UNIVERSAL PLUS	DUAL AJUSTABLE TWO PIECE 2 PULGADAS	BOTÓN DUAL REDONDO	KIT DUAL 2 PULGADAS	ASIENTO ACTIVE ALONGADO
REF.: 022850001	REF.: 799310001	REF.: 021530001	REF.: 818250001	REF.: 609461001
022853331	816515551	021535551	818255551	
022855551				
022856661				

COMPATIBLES CON KITS DE INSTALACIÓN

 KIT 1
 KIT 2

SANITARIO AVANTI PLUS
DOS PIEZAS / TAZA ALONGADA

VÁLVULA DE LLENADO	VÁLVULA DE DESCARGA	ACCIONAMIENTO	GRIFERÍA TANQUE	ASIENTO
				
HIDRO PLUS BAJA	NUKI 26 CM	BOTÓN 58 MM + CATAPULTA	KIT DUAL 2 PULGADAS	ASIENTO AERO ALONGADO
REF.: 302991001	REF.: 806200001	REF.: 025020001	REF.: 818250001	REF.: 85900AAA1
	806203331		818255551	
	806205551			

COMPATIBLES CON KITS DE INSTALACIÓN

 KIT 1
 KIT 2

SANITARIO GANAMAX
DOS PIEZAS / TAZA REDONDA

VÁLVULA DE LLENADO	VÁLVULA DE DESCARGA	ACCIONAMIENTO	GRIFERÍA TANQUE	ASIENTO
				
UNIVERSAL PLUS	DUAL AJUSTABLE TWO PIECE 2 PULGADAS	BOTÓN DUAL REDONDO	KIT DUAL 2 PULGADAS	ASIENTO ACTIVE REDONDO
REF.: 022850001	REF.: 799310001	REF.: 021530001	REF.: 818250001	REF.: 609351001
022853331	816515551	021535551	818255551	
022855551				
022856661				

COMPATIBLES CON KITS DE INSTALACIÓN

 KIT 1
 KIT 2

SANITARIO KIDDY BLANCO
DOS PIEZAS

	VÁLVULA DE LLENADO	VÁLVULA DE DESCARGA	ACCIONAMIENTO	GRIFERÍA TANQUE	ASIENTO
					
REF.: 501111001	REF.: 022850001 022853331 022855551 022856661	REF.: 806200001 806203331 806205551	REF.: 039430001		REF.: 609501001
COMPATIBLES CON KITS DE INSTALACIÓN  KIT 1  KIT 2					

SANITARIO HAPPY
DOS PIEZAS / TAZA REDONDA

	VÁLVULA DE LLENADO	VÁLVULA DE DESCARGA	ACCIONAMIENTO	GRIFERÍA TANQUE	ASIENTO
					
REF.: 026201001	REF.: 023070001	REF.: 806100001 806103331 806105551	REF.: 039080001		REF.: 829002221 829003331
COMPATIBLES CON KITS DE INSTALACIÓN  KIT 1  KIT 2					

SANITARIO KIDDY BICOLOR
DOS PIEZAS

	VÁLVULA DE LLENADO	VÁLVULA DE DESCARGA	ACCIONAMIENTO	GRIFERÍA TANQUE	ASIENTO
					
REF.: 501112171	REF.: 022850001 022853331 022855551 022856661	REF.: 806200001 806203331 806205551	REF.: 039430001		REF.: 609501001
COMPATIBLES CON KITS DE INSTALACIÓN  KIT 1  KIT 2					

SANITARIO LAGUNA
DOS PIEZAS

	VÁLVULA DE LLENADO	VÁLVULA DE DESCARGA	ACCIONAMIENTO	GRIFERÍA TANQUE	ASIENTO
					
REF.: 340021001	REF.: 023070001	REF.: 806100001 806103331 806105551	REF.: 025280001	REF.: 818290001	REF.: 909000001
COMPATIBLES CON KITS DE INSTALACIÓN  KIT 1  KIT 2					

SANITARIO KIDDY
ECOFLUSH / DOS PIEZAS

	VÁLVULA DE LLENADO	VÁLVULA DE DESCARGA	ACCIONAMIENTO	GRIFERÍA TANQUE	ASIENTO
					
REF.: 501111001	REF.: 022850001 022853331 022855551 022856661	REF.: 806200001 806203331 806205551	REF.: 039430001		REF.: 609501001
COMPATIBLES CON KITS DE INSTALACIÓN  KIT 1  KIT 2					

SANITARIO MANANTIAL
DOS PIEZAS / TAZA ALONGADA

	VÁLVULA DE LLENADO	VÁLVULA DE DESCARGA	ACCIONAMIENTO	GRIFERÍA TANQUE	ASIENTO
					
REF.: 202941001	REF.: 806373331	REF.: 806200001 806203331 806205551	REF.: 025280001	REF.: 818290001	REF.: 829002221 829003331
COMPATIBLES CON KITS DE INSTALACIÓN  KIT 1  KIT 2					

SANITARIO MAZARA PLUS DOS PIEZAS	VÁLVULA DE LLENADO	VÁLVULA DE DESCARGA	ACCIONAMIENTO	GRIFERÍA TANQUE	ASIENTO
					
REF.: 201011001	REF.: 022850001 022853331 022855551 022856661	REF.: 799310001 816515551	REF.: 021530001 021535551	REF.: 818250001 818255551	REF.: 609391001
COMPATIBLES CON KITS DE INSTALACIÓN  KIT 1  KIT 2					

SANITARIO POWER ONE PALANCA / DOS PIEZAS / TAZA ALONGADA	VÁLVULA DE LLENADO	VÁLVULA DE DESCARGA	ACCIONAMIENTO	GRIFERÍA TANQUE	ASIENTO
					
REF.: 101651001	REF.: 022850001 022853331 022855551 022856661	REF.: 798850001	REF.: 022899991		
COMPATIBLES CON KITS DE INSTALACIÓN					

SANITARIO PIAMONTE PROVENCE AMERICAN STANDARD DOS PIEZAS / TAZA ALONGADA	VÁLVULA DE LLENADO	VÁLVULA DE DESCARGA	ACCIONAMIENTO	GRIFERÍA TANQUE	ASIENTO
					
COMPATIBLES CON KITS DE INSTALACIÓN  KIT 1  KIT 3	REF.: 022850001 022853331 022855551 022856661	REF.: 798850001	REF.: 798840001 EXCLUSIVO PSA		REF.: 839002221

SANITARIO SENSACIÓN DOS PIEZAS / TAZA ALONGADA	VÁLVULA DE LLENADO	VÁLVULA DE DESCARGA	ACCIONAMIENTO	GRIFERÍA TANQUE	ASIENTO
					
REF.: 026451000	REF.: 022850001 022853331 022855551 022856661	REF.: 806200001 806203331 806205551	REF.: 010100001		REF.: 85900AAA1
COMPATIBLES CON KITS DE INSTALACIÓN  KIT 1  KIT 2					

SANITARIO POWER ONE BOTÓN SINGLE / DOS PIEZAS / TAZA ALONGADA	VÁLVULA DE LLENADO	VÁLVULA DE DESCARGA	ACCIONAMIENTO	GRIFERÍA TANQUE	ASIENTO
					
REF.: 020801001	REF.: 022850001 022853331 022855551 022856661	REF.: 816610001	REF.: 024940001 024945551		REF.: 609461001
COMPATIBLES CON KITS DE INSTALACIÓN  KIT 1  KIT 3					

SANITARIO SENSACIÓN PALANCA / DOS PIEZAS	VÁLVULA DE LLENADO	VÁLVULA DE DESCARGA	ACCIONAMIENTO	GRIFERÍA TANQUE	ASIENTO
					
COMPATIBLES CON KITS DE INSTALACIÓN  KIT 1  KIT 2	REF.: 022850001 022853331 022855551 022856661	REF.: 806200001 806203331 806205551	REF.: 010100001 010105551		REF.: 869000001 869003331

SANITARIO SENSACIÓN
BOTÓN PLUS / DOS PIEZAS / TAZA ALONGADA

	VÁLVULA DE LLENADO	VÁLVULA DE DESCARGA	ACCIONAMIENTO	GRIFERÍA TANQUE	ASIENTO
					
	UNIVERSAL PLUS	NUKI 26 CM	BOTÓN 38 MM + CATAPULTA	KIT UNIVERSAL PLUS + BOTÓN 38 MM	ASIENTO COMODOR
	REF:	REF:	REF:	REF:	REF:
	022850001	806200001	025280001	818290001	829002221
	022853331	806203331			829003331
	022855551	806205551			
	022856661				

COMPATIBLES CON KITS DE INSTALACIÓN

 KIT 1
 KIT 2

SANITARIO TREVI DUAL
DOS PIEZAS / TAZA ALONGADA

	VÁLVULA DE LLENADO	VÁLVULA DE DESCARGA	ACCIONAMIENTO	GRIFERÍA TANQUE	ASIENTO
					
	UNIVERSAL PLUS	DUAL AJUSTABLE TWO PIECE 2 PULGADAS	BOTÓN DUAL REDONDO	KIT DUAL 2 PULGADAS	ASIENTO COMODOR
	REF:	REF:	REF:	REF:	REF:
	022850001	799310001	021530001	818250001	829002221
	022853331	816515551	021535551	818255551	829003331
	022855551				
	022856661				

COMPATIBLES CON KITS DE INSTALACIÓN

 KIT 1
 KIT 2

SANITARIO SENSACIÓN
P-TRAP / DOS PIEZAS / TAZA REDONDA

	VÁLVULA DE LLENADO	VÁLVULA DE DESCARGA	ACCIONAMIENTO	GRIFERÍA TANQUE	ASIENTO
					
	UNIVERSAL PLUS	NUKI 26 CM	BOTÓN 38 MM + CATAPULTA	KIT UNIVERSAL PLUS + BOTÓN 38 MM	ASIENTO AERO REDONDO
	REF:	REF:	REF:	REF:	REF:
	022850001	806200001	025280001	818290001	859002221
	022853331	806203331			
	022855551	806205551			
	022856661				

COMPATIBLES CON KITS DE INSTALACIÓN

 KIT 1
 KIT 2

SANITARIO QUADRATO
PLUS / DOS PIEZAS / TAZA REDONDA

	VÁLVULA DE LLENADO	VÁLVULA DE DESCARGA	ACCIONAMIENTO	GRIFERÍA TANQUE	ASIENTO
					
	UNIVERSAL PLUS	DUAL AJUSTABLE TWO PIECE 2 PULGADAS	BOTÓN DUAL REDONDO	KIT DUAL 2 PULGADAS	ASIENTO QUADRATO
	REF:	REF:	REF:	REF:	REF:
	520411001	799310001	021530001	818250001	609381001
	022853331	816515551	021535551	818255551	
	022855551				
	022856661				

COMPATIBLES CON KITS DE INSTALACIÓN

 KIT 1
 KIT 3

SANITARIO TREVI
DOS PIEZAS / TAZA ALONGADA

	VÁLVULA DE LLENADO	VÁLVULA DE DESCARGA	ACCIONAMIENTO	GRIFERÍA TANQUE	ASIENTO
					
	ATLAS PLUS 26 CM	NUKI 26 CM	MANIJA GRIVAL	KIT ATLAS / NUKI 26 CM	ASIENTO BASIC
	REF:	REF:	REF:	REF:	REF:
	806330001	806200001	937500001	806320001	869000001
	806333331	806203331	937505551	806325551	869003331
	806335551	806205551			

COMPATIBLES CON KITS DE INSTALACIÓN

 KIT 1
 KIT 2

SANITARIO MANAOS
SINGLE / DOS PIEZAS / TAZA REDONDA

	VÁLVULA DE LLENADO	VÁLVULA DE DESCARGA	ACCIONAMIENTO	GRIFERÍA TANQUE	ASIENTO
					
	UNIVERSAL PLUS	ECOCLEAN			ASIENTO AERO REDONDO
	REF:	REF:			REF:
	022850001	816610001			859002221
	022853331				
	022855551				
	022856661				

COMPATIBLES CON KITS DE INSTALACIÓN

SANITARIO RECIFE DOS PIEZAS / TAZA ALONGADA		VÁLVULA DE LLENADO	VÁLVULA DE DESCARGA	ACCIONAMIENTO	GRIFERÍA TANQUE	ASIENTO
 COMPATIBLES CON KITS DE INSTALACIÓN	 UNIVERSAL PLUS REF.: 022850001 022853331 022855551 022856661	 ECOCLEAN REF.: 816610001			 ASIENTO AERO ALONGADO REF.: 85900AAA1	

SANITARIO BROADWAY DOS PIEZAS / TAZA ALONGADA		VÁLVULA DE LLENADO	VÁLVULA DE DESCARGA	ACCIONAMIENTO	GRIFERÍA TANQUE	ASIENTO
 COMPATIBLES CON KITS DE INSTALACIÓN	 UNIVERSAL PLUS REF.: 022850001 022853331 022855551 022856661	 PIAMONTE 3 PULGADAS REF.: 798850001	 BOTÓN 38 MM NO REQUIERE CATAPULTA REF.: 025280001		 ASIENTO BURGOS REF.: 609741001	

SANITARIO BAIA DUAL / DOS PIEZAS / TAZA ALONGADA		VÁLVULA DE LLENADO	VÁLVULA DE DESCARGA	ACCIONAMIENTO	GRIFERÍA TANQUE	ASIENTO
 COMPATIBLES CON KITS DE INSTALACIÓN	 UNIVERSAL PLUS REF.: 022850001 022853331 022855551 022856661	 DUAL AJUSTABLE TWO PIECE 2 PULGADAS REF.: 799310001 816515551	 BOTÓN DUAL DE 48 MM REF.: 025710001		 ASIENTO AERO ALONGADO REF.: 85900AAA1	

SANITARIO MONTECARLO NOVO HET / UNA PIEZA / TAZA ALONGADA		VÁLVULA DE LLENADO	VÁLVULA DE DESCARGA	ACCIONAMIENTO	GRIFERÍA TANQUE	ASIENTO
 COMPATIBLES CON KITS DE INSTALACIÓN ■ KIT 1 ■ KIT 3	 UNIVERSAL PLUS REF.: 022850001 022853331 022855551 022856661	 DUAL AJUSTABLE ONE PIECE 3 PULGADAS REF.: 816420001 816525551	 BOTÓN DUAL ALONGADO REF.: 024070001 024075551		 ASIENTO ACTIVE ALONGADO REF.: 609461001	

SANITARIO BAIA SINGLE / DOS PIEZAS / TAZA ALONGADA		VÁLVULA DE LLENADO	VÁLVULA DE DESCARGA	ACCIONAMIENTO	GRIFERÍA TANQUE	ASIENTO
 COMPATIBLES CON KITS DE INSTALACIÓN	 UNIVERSAL PLUS REF.: 022850001 022853331 022855551 022856661	 ECOCLEAN REF.: 816610001	 BOTÓN 38 MM NO REQUIERE CATAPULTA REF.: 025280001		 ASIENTO AERO ALONGADO REF.: 85900AAA1	

SANITARIO MONTECARLO NOVO HET / UNA PIEZA / TAZA REDONDA		VÁLVULA DE LLENADO	VÁLVULA DE DESCARGA	ACCIONAMIENTO	GRIFERÍA TANQUE	ASIENTO
 COMPATIBLES CON KITS DE INSTALACIÓN ■ KIT 2 ■ KIT 3	 UNIVERSAL PLUS REF.: 022850001 022853331 022855551 022856661	 DUAL AJUSTABLE ONE PIECE 3 PULGADAS REF.: 816420001 816525551	 BOTÓN DUAL ALONGADO REF.: 024070001 024075551		 ASIENTO ACTIVE REDONDO REF.: 609351001	

SANITARIO MONTECARLO
ADVANCE / UNA PIEZA / TAZA A LONGADA

	VÁLVULA DE LLENADO	VÁLVULA DE DESCARGA	ACCIONAMIENTO	GRIFERÍA TANQUE	ASIENTO
					
REF.: 029201001	REF.: 022900001	REF.: 022910001	REF.: 909089991	REF.: 977020001	
COMPATIBLES CON KITS DE INSTALACIÓN					
 KIT 2					
 KIT 3					

SANITARIO MONTECARLO
ADVANCE / UNA PIEZA / TAZA REDONDA

	VÁLVULA DE LLENADO	VÁLVULA DE DESCARGA	ACCIONAMIENTO	GRIFERÍA TANQUE	ASIENTO
					
REF.: 029091001	REF.: 022900001	REF.: 022910001	REF.: 909089991	REF.: 959080001	
COMPATIBLES CON KITS DE INSTALACIÓN					
 KIT 2					
 KIT 3					

SANITARIO SAN GIORGIO
2 PULGADAS / UNA PIEZA / TAZA A LONGADA

	VÁLVULA DE LLENADO	VÁLVULA DE DESCARGA	ACCIONAMIENTO	GRIFERÍA TANQUE	ASIENTO
					
REF.: 121361001	REF.: 022850001 022853331 022855551 022856661	REF.: 799140001 816475551	REF.: 021530001 021535551	REF.: 818270001 818275551	REF.: 609461001
COMPATIBLES CON KITS DE INSTALACIÓN					
 KIT 1					
 KIT 3					

SANITARIO SAN GIORGIO
2 PULGADAS / UNA PIEZA / TAZA REDONDA

	VÁLVULA DE LLENADO	VÁLVULA DE DESCARGA	ACCIONAMIENTO	GRIFERÍA TANQUE	ASIENTO
					
REF.: 022850001 022853331 022855551 022856661	REF.: 022850001 022853331 022855551 022856661	REF.: 799140001 816475551	REF.: 021530001 021535551	REF.: 818270001 818275551	REF.: 609351001
COMPATIBLES CON KITS DE INSTALACIÓN					
 KIT 1					
 KIT 3					

SANITARIO SEVILLA
UNA PIEZA / TAZA A LONGADA

	VÁLVULA DE LLENADO	VÁLVULA DE DESCARGA	ACCIONAMIENTO	GRIFERÍA TANQUE	ASIENTO
					
REF.: 022850001 022853331 022855551 022856661	REF.: 022850001 022853331 022855551 022856661	REF.: 799140001 816475551	REF.: 025710001	REF.: 609471001	
COMPATIBLES CON KITS DE INSTALACIÓN					
 Kit 1					
 KIT 2					

SANITARIO KALAVI
TAZA A LONGADA

	VÁLVULA DE LLENADO	VÁLVULA DE DESCARGA	ACCIONAMIENTO	GRIFERÍA TANQUE	ASIENTO
					
REF.: 022850001 022853331 022855551 022856661	REF.: 022850001 022853331 022855551 022856661	REF.: 738000001 738005551	REF.: 025280001	REF.: 85900AAA1	
COMPATIBLES CON KITS DE INSTALACIÓN					

SANITARIO SMART SINGLE / UNA PIEZA / TAZA ALONGADA		VÁLVULA DE LLENADO	VÁLVULA DE DESCARGA	ACCIONAMIENTO	GRIFERÍA TANQUE	ASIENTO
 <p>COMPATIBLES CON KITS DE INSTALACIÓN</p> <p>KIT 1</p> <p>KIT 2</p>						
	UNIVERSAL PLUS	NUKI ONE PIECE 2 PULGADAS	BOTÓN 58 MM	ASIENTO VERSATILE ALONGADO		
	REF:	REF:	REF:	REF:		
	022850001 022853331 022855551 022856661	738020001 738025551	024940001 024945551	977020001		

SANITARIO SMART SINGLE / UNA PIEZA / TAZA REDONDA		VÁLVULA DE LLENADO	VÁLVULA DE DESCARGA	ACCIONAMIENTO	GRIFERÍA TANQUE	ASIENTO
 <p>COMPATIBLES CON KITS DE INSTALACIÓN</p> <p>KIT 1</p> <p>KIT 2</p>						
	UNIVERSAL PLUS	NUKI ONE PIECE 2 PULGADAS	BOTÓN 58 MM	ASIENTO VERSATILE REDONDO		
	REF:	REF:	REF:	REF:		
	022850001 022853331 022855551 022856661	738020001 738025551	024940001 024945551	959080001		

SANITARIO SOLARE SINGLE / UNA PIEZA / TAZA ALONGADA		VÁLVULA DE LLENADO	VÁLVULA DE DESCARGA	ACCIONAMIENTO	GRIFERÍA TANQUE	ASIENTO
 <p>REF.: 060721001</p> <p>COMPATIBLES CON KITS DE INSTALACIÓN</p>						
	UNIVERSAL PLUS	TORRE 3 PULGADAS SINGLE	BOTÓN 58 MM	ASIENTO SOLARE		
	REF:	REF:	REF:	REF:		
	022850001 022853331 022855551 022856661	816600001	024940001 024945551	609481001		

SANITARIO FUSSION UNA PIEZA / TAZA ALONGADA		VÁLVULA DE LLENADO	VÁLVULA DE DESCARGA	ACCIONAMIENTO	GRIFERÍA TANQUE	ASIENTO
 <p>REF.: 121511001</p> <p>COMPATIBLES CON KITS DE INSTALACIÓN</p> <p>KIT 2</p> <p>KIT 3</p>						
	UNIVERSAL PLUS	DUAL AJUSTABLE ONE PIECE 2 PULGADAS	BOTÓN DUAL ALONGADO	KIT DUAL 1 PULGADA (SMR)	ASIENTO FUSSION ALONGADO	
	REF:	REF:	REF:	REF:	REF:	
	022850001 022853331 022855551 022856661	799140001 816475551	024070001 024075551	818270001 818275551	609541001	

SANITARIO PRESTIGIO 4 LITROS / UNA PIEZA / TAZA ALONGADA		VÁLVULA DE LLENADO	VÁLVULA DE DESCARGA	ACCIONAMIENTO	GRIFERÍA TANQUE	ASIENTO
 <p>REF.: 306361001</p> <p>COMPATIBLES CON KITS DE INSTALACIÓN</p> <p>KIT 3</p>						
	SISTEMA DE PRESIÓN ASISTIDA SLOAN FLUSHMATE	BOTÓN 38 MM NO REQUIERE CATAPULTA	ASIENTO PRESTIGIO			
	REF:	REF:	REF:	REF:		
	707420001	025280001	609201001			

SANITARIO VITERBO UNA PIEZA / TAZA ALONGADA		VÁLVULA DE LLENADO	VÁLVULA DE DESCARGA	ACCIONAMIENTO	GRIFERÍA TANQUE	ASIENTO
 <p>COMPATIBLES CON KITS DE INSTALACIÓN</p> <p>KIT 2</p> <p>KIT 3</p>						
	UNIVERSAL PLUS	DUAL AJUSTABLE ONE PIECE 2 PULGADAS	BOTÓN DUAL ALONGADO	KIT DUAL 1 PULGADA (SMR)		
	REF:	REF:	REF:	REF:		
	022850001 022853331 022855551 022856661	799140001 816475551	024070001 024075551	818270001 818275551		

SANITARIO POWERMAX
DOS PIEZAS / TAZA ALONGADA



VÁLVULA DE LLENADO **VÁLVULA DE DESCARGA** **ACCIONAMIENTO** **GRIFERÍA TANQUE** **ASIENTO**



SISTEMA DE PRESIÓN ASISTIDA SLOAN FLUSHMATE

REF.:
707420001



SISTEMA DE PRESIÓN ASISTIDA SLOAN FLUSHMATE

REF.:
707420001



BOTÓN 38 MM + CATAPULTA

REF.:
025280001



ASIENTO CRESCENTO

REF.:
609471001

COMPATIBLES CON KITS DE INSTALACIÓN

SANITARIO CASCADE
UNA PIEZA / TAZA ALONGADA



VÁLVULA DE LLENADO **VÁLVULA DE DESCARGA** **ACCIONAMIENTO** **GRIFERÍA TANQUE** **ASIENTO**



UNIVERSAL PLUS

REF.:
022850001
022853331
022855551
022856661



TORRE 3 PULGADAS SINGLE

REF.:
816600001



BOTÓN 58 MM

REF.:
024940001
024945551

ASIENTO CASCADE

REF.:
609691001

COMPATIBLES CON KITS DE INSTALACIÓN

SANITARIO BURGOS
UNA PIEZA / TAZA ALONGADA



VÁLVULA DE LLENADO **VÁLVULA DE DESCARGA** **ACCIONAMIENTO** **GRIFERÍA TANQUE** **ASIENTO**



UNIVERSAL PLUS

REF.:
022850001
022853331
022855551
022856661



DUAL AJUSTABLE ONE PIECE 3 PULGADAS

REF.:
816420001
816525551



BOTÓN DUAL ALONGADO

REF.:
024070001
024075551



ASIENTO BURGOS

REF.:
609741001

COMPATIBLES CON KITS DE INSTALACIÓN

SANITARIO OPORTO
UNA PIEZA / TAZA ALONGADA



VÁLVULA DE LLENADO **VÁLVULA DE DESCARGA** **ACCIONAMIENTO** **GRIFERÍA TANQUE** **ASIENTO**



UNIVERSAL PLUS

REF.:
022850001
022853331
022855551
022856661



DUAL AJUSTABLE ONE PIECE 2 PULGADAS

REF.:
799140001
816475551



BOTÓN DUAL REDONDO

REF.:
021530001
021535551



ASIENTO ACTIVE ALONGADO

REF.:
609461001

COMPATIBLES CON KITS DE INSTALACIÓN

SANITARIOS DESCONTINUADOS

SANITARIO ACUARIO

DOS PIEZAS



VÁLVULA DE LLENADO



ATLAS PLUS
26 CM

REF.:

806330001

806333331

806335551

VÁLVULA DE DESCARGA



NUKI
26 CM

REF.:

806200001

806203331

806205551

ACCIONAMIENTO



MANIJA
CROMO

REF.:

010100001

010105551

GRIFERÍA TANQUE



KIT ATLAS /
NUKI 26 CM

REF.:

806320001

806325551

ASIENTO



ASIENTO COMODOR

REF.:

829002221

829003331

COMPATIBLES CON
KITS DE INSTALACIÓN

KIT 1

KIT 2

SANITARIO CYCLONE

ULTRA / DOS PIEZAS



VÁLVULA DE LLENADO



FLUSHMATE 4MC
PUSH BOTÓN

REF.:

717410001

VÁLVULA DE DESCARGA



BOTÓN 58 MM
NO REQUIERE
CATAPULTA

REF.:

025020001

GRIFERÍA TANQUE



ASIENTO ACTIVE
ALONGADO

REF.:

609461001

COMPATIBLES CON
KITS DE INSTALACIÓN

KIT 2

KIT 3

SANITARIO NOVARA HET

DOS PIEZAS



VÁLVULA DE LLENADO



ATLAS PLUS
32 CM

REF.:

806343331

806355551

VÁLVULA DE DESCARGA



NUKI
32 CM

REF.:

806100001

806103331

806105551

ACCIONAMIENTO



MANIJA
GRIVAL

REF.:

937500001

937505551

937513331

GRIFERÍA TANQUE



KIT ATLAS /
NUKI 26 CM

REF.:

806320001

806325551

ASIENTO



ASIENTO
LUXOR

REF.:

839002221

COMPATIBLES CON
KITS DE INSTALACIÓN

KIT 1

KIT 2

CONTENIDO

SANITARIO PORTENTO

PLUS / DOS PIEZAS



VÁLVULA DE LLENADO



UNIVERSAL
PLUS

REF.:

022850001

022853331

022855551

022856661

VÁLVULA DE DESCARGA



PIAMONTE 3
PULGADAS

REF.:

798850001

ACCIONAMIENTO



MANIJA
CROMO

REF.:

010100001

010105551

GRIFERÍA TANQUE



KIT ATLAS /
NUKI 26 CM

REF.:

806320001

806325551

ASIENTO



ASIENTO ACTIVE
ALONGADO

REF.:

609461001

COMPATIBLES CON
KITS DE INSTALACIÓN

KIT 1

KIT 3

SANITARIO REGGIO

DOS PIEZAS



VÁLVULA DE LLENADO



UNIVERSAL PLUS

REF.:

022850001

022853331

022855551

022856661

VÁLVULA DE DESCARGA



PIAMONTE 3
PULGADAS

REF.:

798850001

ACCIONAMIENTO



MANIJA
CROMO

REF.:

010100001

010105551

GRIFERÍA TANQUE



KIT ATLAS /
NUKI 26 CM

REF.:

806320001

806325551

ASIENTO



ASIENTO PRESTIGIO

REF.:

609201001

COMPATIBLES CON
KITS DE INSTALACIÓN

KIT 1

KIT 3

SANITARIO STILO

DOS PIEZAS



VÁLVULA DE LLENADO



ATLAS PLUS
26 CM

REF.:

806330001

806333331

806335551

VÁLVULA DE DESCARGA



NUKI
26 CM

REF.:

806200001

806203331

806205551

ACCIONAMIENTO



MANIJA
GRIVAL

REF.:

937500001

937505551

937513331

GRIFERÍA TANQUE



KIT ATLAS /
NUKI 26 CM

REF.:

806320001

806325551

ASIENTO



ASIENTO AERO
ALONGADO

REF.:

85900AAA1

COMPATIBLES CON
KITS DE INSTALACIÓN

KIT 2

KIT 3

SANITARIO BARI UNA PIEZA	VÁLVULA DE LLENADO	VÁLVULA DE DESCARGA	ACCIONAMIENTO	GRIFERÍA TANQUE	ASIENTO
					
COMPATIBLES CON KITS DE INSTALACIÓN  KIT 2  KIT 3	UNIVERSAL PLUS	DUAL AJUSTABLE ONE PIECE 2 PULGADAS	BOTÓN DUAL REDONDO	KIT DUAL 1 PULGADA (SMR)	ASIENTO BRONZO
	REF:	REF:	REF:	REF:	REF:
	022850001	799140001	021530001	818270001	609401001
	022853331	816475551	021535551	818275551	
	022855551				
022856661					

SANITARIO GALES DOS PIEZAS	VÁLVULA DE LLENADO	VÁLVULA DE DESCARGA	ACCIONAMIENTO	GRIFERÍA TANQUE	ASIENTO
					
COMPATIBLES CON KITS DE INSTALACIÓN  KIT 1  KIT 3	UNIVERSAL PLUS	DUAL AJUSTABLE ONE PIECE 2 PULGADAS	BOTÓN DUAL REDONDO	KIT DUAL 1 PULGADA (SMR)	
	REF:	REF:	REF:	REF:	
	022850001	799140001	021530001	818270001	
	022853331	816475551	021535551	818275551	
	022855551				
022856661					

SANITARIO CAPRI UNA PIEZA	VÁLVULA DE LLENADO	VÁLVULA DE DESCARGA	ACCIONAMIENTO	GRIFERÍA TANQUE	ASIENTO
					
COMPATIBLES CON KITS DE INSTALACIÓN  KIT 2  KIT 3	UNIVERSAL PLUS	DUAL AJUSTABLE ONE PIECE 2 PULGADAS	BOTÓN DUAL REDONDO	KIT DUAL 1 PULGADA (SMR)	
	REF:	REF:	REF:	REF:	
	022850001	799140001	021530001	818270001	
	022853331	816475551	021535551	818275551	
	022855551				
022856661					

SANITARIO EBOLI UNA PIEZA	VÁLVULA DE LLENADO	VÁLVULA DE DESCARGA	ACCIONAMIENTO	GRIFERÍA TANQUE	ASIENTO
					
COMPATIBLES CON KITS DE INSTALACIÓN  KIT 1  KIT 3	UNIVERSAL PLUS	DUAL AJUSTABLE ONE PIECE 2 PULGADAS	BOTÓN DUAL ALONGADO	KIT DUAL 1 PULGADA (SMR)	
	REF:	REF:	REF:	REF:	
	022850001	799140001	024070001	818270001	
	022853331	816475551	024075551	818275551	
	022855551				
022856661					

SANITARIO CRESCENTO DOS PIEZAS	VÁLVULA DE LLENADO	VÁLVULA DE DESCARGA	ACCIONAMIENTO	GRIFERÍA TANQUE	ASIENTO
					
COMPATIBLES CON KITS DE INSTALACIÓN  KIT 2  KIT 3	UNIVERSAL PLUS	DUAL AJUSTABLE ONE PIECE 3 PULGADAS	BOTÓN DUAL ALONGADO	KIT DUAL 1 PULGADA (SMR)	ASIENTO CRESCENTO
	REF:	REF:	REF:	REF:	
	022850001	816420001	024070001	818270001	
	022853331	816525551	024075551	818275551	
	022855551				
022856661					

SANITARIO NAPOLI UNA PIEZA	VÁLVULA DE LLENADO	VÁLVULA DE DESCARGA	ACCIONAMIENTO	GRIFERÍA TANQUE	ASIENTO
					
COMPATIBLES CON KITS DE INSTALACIÓN  KIT 2  KIT 3	UNIVERSAL PLUS	DUAL AJUSTABLE ONE PIECE 2 PULGADAS	BOTÓN DUAL ALONGADO	KIT DUAL 1 PULGADA (SMR)	
	REF:	REF:	REF:	REF:	
	022850001	799140001	024070001	818270001	
	022853331	816475551	024075551	818275551	
	022855551				
022856661					

SANITARIO DISTINCIÓN
DOS PIEZAS

VÁLVULA DE LLENADO	VÁLVULA DE DESCARGA	ACCIONAMIENTO	GRIFERÍA TANQUE	ASIENTO
				
ATLAS PLUS 26 CM	NUKI 26 CM	MANIJA CROMO		ASIENTO COMODOR
REF.: 806330001 806333331 806335551	REF.: 806200001 806203331 806205551	REF.: 010100001 010105551		REF.: 829002221 829003331

COMPATIBLES CON KITS DE INSTALACIÓN
 KIT 1
 KIT 2

SANITARIO POTENZA
PLUS / DOS PIEZAS / TAZA ALONGADA

VÁLVULA DE LLENADO	VÁLVULA DE DESCARGA	ACCIONAMIENTO	GRIFERÍA TANQUE	ASIENTO
				
UNIVERSAL PLUS	DUAL AJUSTABLE TWO PIECE 2 PULGADAS	BOTÓN DUAL REDONDO	KIT DUAL 2 PULGADAS	ASIENTO ACTIVE ALONGADO
REF.: 022850001 022853331 022855551 022856661	REF.: 799310001 816515551	REF.: 021530001 021535551	REF.: 818250001 818255551	REF.: 609461001

COMPATIBLES CON KITS DE INSTALACIÓN
 KIT 1
 KIT 2

SANITARIO ENSO
ELEMENTO AMERICAN STANDARD
DOS PIEZAS / TAZA ALONGADA

VÁLVULA DE LLENADO	VÁLVULA DE DESCARGA	ACCIONAMIENTO	GRIFERÍA TANQUE	ASIENTO
				
UNIVERSAL PLUS	ENSO	BOTÓN DUAL REDONDO		ASIENTO ENSO
REF.: 022850001 022853331 022855551 022856661	REF.: 707920001 EXCLUSIVO PSA	REF.: 021530001 021535551		REF.: 619341001

COMPATIBLES CON KITS DE INSTALACIÓN
 KIT 2
 KIT 3

SANITARIO TAO
DOS PIEZAS / TAZA REDONDA

VÁLVULA DE LLENADO	VÁLVULA DE DESCARGA	ACCIONAMIENTO	GRIFERÍA TANQUE	ASIENTO
				
UNIVERSAL PLUS	DUAL AJUSTABLE TWO PIECE 2 PULGADAS	BOTÓN DUAL REDONDO	KIT DUAL 2 PULGADAS	ASIENTO AERO REDONDO
REF.: 022850001 022853331 022855551 022856661	REF.: 799310001 816515551	REF.: 021530001 021535551	REF.: 818250001 818255551	REF.: 859002221

COMPATIBLES CON KITS DE INSTALACIÓN
 KIT 1
 KIT 3

SANITARIO POTENZA
PLUS / DOS PIEZAS / TAZA REDONDA

VÁLVULA DE LLENADO	VÁLVULA DE DESCARGA	ACCIONAMIENTO	GRIFERÍA TANQUE	ASIENTO
				
UNIVERSAL PLUS	DUAL AJUSTABLE TWO PIECE 2 PULGADAS	BOTÓN DUAL REDONDO	KIT DUAL 2 PULGADAS	ASIENTO AERO REDONDO
REF.: 022850001 022853331 022855551 022856661	REF.: 799310001 816515551	REF.: 021530001 021535551	REF.: 818250001 818255551	REF.: 859002221

COMPATIBLES CON KITS DE INSTALACIÓN
 KIT 1
 KIT 2

SANITARIO TAO
UNA PIEZA

VÁLVULA DE LLENADO	VÁLVULA DE DESCARGA	ACCIONAMIENTO	GRIFERÍA TANQUE	ASIENTO
				
ATLAS PLUS 26 CM	NUKI 26 CM	BOTÓN 58 MM + CATAPULTA		
REF.: 806330001 806333331 806335551	REF.: 806200001 806203331 806205551	REF.:		

COMPATIBLES CON KITS DE INSTALACIÓN

SANITARIO BRONZO
UNA PIEZA



VÁLVULA DE LLENADO	VÁLVULA DE DESCARGA	ACCIONAMIENTO	GRIFERÍA TANQUE	ASIENTO
				
UNIVERSAL PLUS	DUAL AJUSTABLE ONE PIECE 2 PULGADAS	BOTÓN DUAL REDONDO	KIT DUAL 1 PULGADA (SMR)	ASIENTO BRONZO
REF.:	REF.:	REF.:	REF.:	REF.:
022850001	799140001	021530001	818270001	609401001
022853331	816475551	021535551	818275551	
022855551				
022856661				

COMPATIBLES CON KITS DE INSTALACIÓN

KIT 2
KIT 3

SANITARIO SELECTA
PALANCA / UNA PIEZA / TAZA ALONGADA



VÁLVULA DE LLENADO	VÁLVULA DE DESCARGA	ACCIONAMIENTO	GRIFERÍA TANQUE	ASIENTO
				
UNIVERSAL PLUS	NUKI ONE PIECE 2 PULGADAS	BOTÓN SINGLE AVANTI		ASIENTO VERSATILE ALONGADO
REF.:	REF.:	REF.:		REF.:
022850001	738020001	018090001		977020001
022853331	738025551			
022855551				
022856661				

COMPATIBLES CON KITS DE INSTALACIÓN

KIT 2
KIT 3

SANITARIO IMOLA
UNA PIEZA



VÁLVULA DE LLENADO	VÁLVULA DE DESCARGA	ACCIONAMIENTO	GRIFERÍA TANQUE	ASIENTO
				
UNIVERSAL PLUS	DUAL AJUSTABLE ONE PIECE 3 PULGADAS	BOTÓN DUAL REDONDO		
REF.:	REF.:	REF.:		
022850001	816420001	021530001		
022853331	816525551	021535551		
022855551				
022856661				

COMPATIBLES CON KITS DE INSTALACIÓN

KIT 2
KIT 3

SANITARIO MÁXIMO
PLUS / DOS PIEZAS



VÁLVULA DE LLENADO	VÁLVULA DE DESCARGA	ACCIONAMIENTO	GRIFERÍA TANQUE	ASIENTO
				
UNIVERSAL PLUS	DUAL AJUSTABLE TWO PIECE 2 PULGADAS	BOTÓN DUAL REDONDO	KIT DUAL 2 PULGADAS	ASIENTO ACTIVE ALONGADO
REF.:	REF.:	REF.:	REF.:	REF.:
022850001	799310001	021530001	818250001	609461001
022853331	816515551	021535551	818255551	
022855551				
022856661				

COMPATIBLES CON KITS DE INSTALACIÓN

KIT 1
KIT 2

SANITARIO SELECTA
UNA PIEZA / TAZA ALONGADA



VÁLVULA DE LLENADO	VÁLVULA DE DESCARGA	ACCIONAMIENTO	GRIFERÍA TANQUE	ASIENTO
				
UNIVERSAL PLUS	DUAL AJUSTABLE ONE PIECE 2 PULGADAS	BOTÓN DUAL REDONDO	KIT DUAL 1 PULGADA (SMR)	ASIENTO VERSATILE ALONGADO
REF.:	REF.:	REF.:	REF.:	REF.:
022850001	799140001	021530001	818270001	977020001
022853331	816475551	021535551	818275551	
022855551				
022856661				

COMPATIBLES CON KITS DE INSTALACIÓN

KIT 2
KIT 3

SANITARIO TAO DIAQUA
DOS PIEZAS



VÁLVULA DE LLENADO	VÁLVULA DE DESCARGA	ACCIONAMIENTO	GRIFERÍA TANQUE	ASIENTO
				
UNIVERSAL PLUS	DUAL AJUSTABLE TWO PIECE 2 PULGADAS	BOTÓN DUAL REDONDO	KIT DUAL 2 PULGADAS	ASIENTO AERO REDONDO
REF.:	REF.:	REF.:	REF.:	REF.:
022850001	799310001	021530001	818250001	859002221
022853331	816515551	021535551	818255551	
022855551				
022856661				

COMPATIBLES CON KITS DE INSTALACIÓN

SANITARIO NIZA UNA PIEZA	VÁLVULA DE LLENADO	VÁLVULA DE DESCARGA	ACCIONAMIENTO	GRIFERÍA TANQUE	ASIENTO
					
	UNIVERSAL PLUS	DUAL AJUSTABLE ONE PIECE 2 PULGADAS	BOTÓN DUAL REDONDO	KIT DUAL 1 PULGADA (SMR)	
	REF.: 022850001 022853331 022855551 022856661	REF.: 799140001 816475551	REF.: 021530001 021535551	REF.: 818270001 818275551	
COMPATIBLES CON KITS DE INSTALACIÓN KIT 2 KIT 3					

SANITARIO ECOCLEAN DUAL / DOS PIEZAS	VÁLVULA DE LLENADO	VÁLVULA DE DESCARGA	ACCIONAMIENTO	GRIFERÍA TANQUE	ASIENTO
					
	UNIVERSAL PLUS	DUAL AJUSTABLE TWO PIECE 3 PULGADAS	BOTÓN DUAL ALONGADO	KIT DUAL 1 PULGADA (SMR)	ASIENTO CRESCENTO
	REF.: 022850001 022853331 022855551 022856661	REF.: 799290001 816495551	REF.: 024070001 024075551		REF.: 609471001
COMPATIBLES CON KITS DE INSTALACIÓN KIT 2 KIT 3					

SANITARIO SONDRIO UNA PIEZA / TAZA ALONGADA	VÁLVULA DE LLENADO	VÁLVULA DE DESCARGA	ACCIONAMIENTO	GRIFERÍA TANQUE	ASIENTO
					
	UNIVERSAL PLUS	DUAL AJUSTABLE ONE PIECE 2 PULGADAS	BOTÓN DUAL REDONDO	KIT DUAL 1 PULGADA (SMR)	ASIENTO BRONZO
	REF.: 022850001 022853331 022855551 022856661	REF.: 799140001 816475551	REF.: 021530001 021535551	REF.: 818270001 818275551	REF.: 609401001
COMPATIBLES CON KITS DE INSTALACIÓN KIT 2 KIT 3					

SANITARIO MONTECARLO NOVO / UNA PIEZA / TAZA ALONGADA	VÁLVULA DE LLENADO	VÁLVULA DE DESCARGA	ACCIONAMIENTO	GRIFERÍA TANQUE	ASIENTO
					
	UNIVERSAL PLUS	DUAL AJUSTABLE ONE PIECE 2 PULGADAS	BOTÓN DUAL ALONGADO	KIT DUAL 1 PULGADA (SMR)	ASIENTO ACTIVE ALONGADO
	REF.: 022850001 022853331 022855551 022856661	REF.: 799140001 816475551	REF.: 024070001 024075551	REF.: 818270001 818275551	REF.: 609461001
COMPATIBLES CON KITS DE INSTALACIÓN KIT 1 KIT 3					

SANITARIO PRESTIGIO 6 LITROS / UNA PIEZA / TAZA ALONGADA	VÁLVULA DE LLENADO	VÁLVULA DE DESCARGA	ACCIONAMIENTO	GRIFERÍA TANQUE	ASIENTO
					
	SISTEMA DE PRESIÓN ASISTIDA SLOAN FLUSHMATE	DUAL AJUSTABLE ONE PIECE 2 PULGADAS	BOTÓN 38 MM + CATAPULTA	KIT DUAL 1 PULGADA (SMR)	ASIENTO PRESTIGIO
	REF.: 799370001		REF.: 025280001		REF.: 609201001
COMPATIBLES CON KITS DE INSTALACIÓN					

SANITARIO MONTECARLO NOVO / UNA PIEZA / TAZA REDONDA	VÁLVULA DE LLENADO	VÁLVULA DE DESCARGA	ACCIONAMIENTO	GRIFERÍA TANQUE	ASIENTO
					
	UNIVERSAL PLUS	DUAL AJUSTABLE ONE PIECE 2 PULGADAS	BOTÓN DUAL ALONGADO	KIT DUAL 1 PULGADA (SMR)	ASIENTO ACTIVE REDONDO
	REF.: 022850001 022853331 022855551 022856661	REF.: 799140001 816475551	REF.: 024070001 024075551	REF.: 818270001 818275551	REF.: 609351001
COMPATIBLES CON KITS DE INSTALACIÓN KIT 2 KIT 3					

SANITARIO SMART
DUAL / UNA PIEZA / TAZA ALONGADA



VÁLVULA DE LLENADO	VÁLVULA DE DESCARGA	ACCIONAMIENTO	GRIFERÍA TANQUE	ASIENTO
				
UNIVERSAL PLUS	DUAL AJUSTABLE ONE PIECE 2 PULGADAS	BOTÓN DUAL ALONGADO	KIT DUAL 1 PULGADA (SMR)	ASIENTO VERSATILE ALONGADO
REF.:	REF.:	REF.:	REF.:	REF.:
022850001	799140001	024070001	818270001	977020001
022853331	816475551	024075551	818275551	
022855551				
022856661				

COMPATIBLES CON KITS DE INSTALACIÓN

 KIT 1
 KIT 2

SANITARIO LUGO
TAZA ALONGADA



VÁLVULA DE LLENADO	VÁLVULA DE DESCARGA	ACCIONAMIENTO	GRIFERÍA TANQUE	ASIENTO
				
UNIVERSAL PLUS	DUAL AJUSTABLE ONE PIECE 2 PULGADAS	BOTÓN DUAL DE 48 MM		ASIENTO CRESCENTO
REF.:	REF.:	REF.:		REF.:
022850001	799140001	025710001		609471001
022853331	816475551			
022855551				
022856661				

COMPATIBLES CON KITS DE INSTALACIÓN

 KIT 1
 KIT 2

SANITARIO SMART
DUAL / UNA PIEZA / TAZA REDONDA



VÁLVULA DE LLENADO	VÁLVULA DE DESCARGA	ACCIONAMIENTO	GRIFERÍA TANQUE	ASIENTO
				
UNIVERSAL PLUS	DUAL AJUSTABLE ONE PIECE 2 PULGADAS	BOTÓN DUAL ALONGADO	KIT DUAL 1 PULGADA (SMR)	ASIENTO VERSATILE REDONDO
REF.:	REF.:	REF.:	REF.:	REF.:
029211001	799140001	024070001	818270001	959080001
022853331	816475551	024075551	818275551	
022855551				
022856661				

COMPATIBLES CON KITS DE INSTALACIÓN

 KIT 1
 KIT 2

SANITARIO BILBAO
TAZA ALONGADA



VÁLVULA DE LLENADO	VÁLVULA DE DESCARGA	ACCIONAMIENTO	GRIFERÍA TANQUE	ASIENTO
				
UNIVERSAL PLUS	DUAL AJUSTABLE ONE PIECE 2 PULGADAS	BOTÓN DUAL DE 48 MM		ASIENTO CRESCENTO
REF.:	REF.:	REF.:		REF.:
022850001	799140001	025710001		609471001
022853331	816475551			
022855551				
022856661				

COMPATIBLES CON KITS DE INSTALACIÓN

 KIT 1
 KIT 2

SANITARIO SOLARE
UNA PIEZA / TAZA ALONGADA



VÁLVULA DE LLENADO	VÁLVULA DE DESCARGA	ACCIONAMIENTO	GRIFERÍA TANQUE	ASIENTO
				
UNIVERSAL PLUS	DUAL AJUSTABLE ONE PIECE 3 PULGADAS	BOTÓN DUAL ALONGADO		ASIENTO SOLARE
REF.:	REF.:	REF.:		REF.:
022850001	816420001	024070001		609481001
022853331	816525551	024075551		
022855551				
022856661				

COMPATIBLES CON KITS DE INSTALACIÓN

 KIT 2
 KIT 3

KIT DE INSTALACIÓN

KIT 1



REGULACIÓN PLÁSTICA

REF.:	PAQUETE	DIÁMETRO
957900001	Und.	½ pulg.
MY 957903331	x6	½ pulg.
957905551	Und.	½ pulg.



GRIFLEX SANITARIO 40 CM

REF.:	PAQUETE	DIÁMETRO
380130001	Und.	½ - 7/8 pulg.
380135551	Und.	½ - 7/8 pulg.
MY 380193331	x12	½ - 7/8 pulg.



REGULACIÓN PLÁSTICA + ACOPLE SANITARIO

REF.:	PAQUETE	DIÁMETRO
967350001	Und.	½ pulg.
MY 967363331	x6	½ pulg.
967355551	Und.	½ pulg.



BRIDA SANITARIA

REF.:	PAQUETE
737600001	Und.

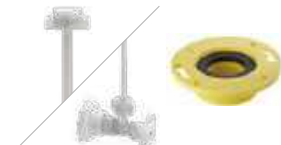

KIT BRIDA + REGULACIÓN + GRIFLEX SANITARIO

REF.:	PAQUETE	DIÁMETRO
937635551	Und.	



TORNILLO FIJACIÓN GRIFERÍA

REF.:	PAQUETE
937400001	Und.



SELLO LENGÜETA CLÁSICO

REF.:	PAQUETE
010060001	Und.



CORDÓN NYLON

REF.:	PAQUETE
967350001	Und.



EMPAQUE TAZA TANQUE

REF.:	PAQUETE
014671111	Und.

KIT 2



REGULACIÓN SATINADA

REF.:	PAQUETE	DIÁMETRO
967670001	Und.	
MY 967673331	x6	
967675551	Und.	



GRIFLEX SANITARIO 40 CM

REF.:	PAQUETE	DIÁMETRO
380130001	Und.	½ - 7/8 pulg.
380135551	Und.	½ - 7/8 pulg.
MY 380193331	x12	½ - 7/8 pulg.



KIT REGULACIÓN SATINADA + ACOPLE SANITARIO

REF.:	PAQUETE	DIÁMETRO
967690001	Und.	
967725551	Und.	



BRIDA SANITARIA

REF.:	PAQUETE
737600001	Und.



SELLO LENGÜETA ÉLITE

REF.:	PAQUETE
017671111	Und.



FLAPPER ADVANCE BCA EN CAJA

REF.:	PAQUETE
023440001	Und.



FLAPPER ADVANCE CORRIENTE

REF.:	PAQUETE
023450001	Und.



HERRAJE SANITARIO COMODOR BLANCO

REF.:	PAQUETE
010920001	Und.

KIT 3



REGULACIÓN METÁLICA CRUCETA

REF.:	PAQUETE	DIÁMETRO
797340001	Und.	½ pulg.
MY 797343331	x3	½ pulg.
797345551	Und.	½ pulg.



ACOPLE SANITARIO 40 CM

REF.:	PAQUETE	DIÁMETRO
022950001	Und.	½ pulg.
022955551	Und.	½ pulg.



KIT DE INSTALACIÓN REGULACIÓN + ACOPLE SANITARIO

REF.:	PAQUETE	DIÁMETRO
931630001	Und.	



BRIDA SANITARIA

REF.:	PAQUETE
737600001	Und.



HERRAJE AERO

REF.:	COLOR
013741111	900 Blanco
013751111	971 Bone



HERRAJE SANITARIO DYNAMIC

REF.:	COLOR
030250001	900 Blanco
030260001	971 Bone



HERRAJE SANITARIO LUXOR

REF.:	COLOR
010990001	Blanco
011000001	Marfil



HERRAJE SANITARIO SENSACIÓN BLANCO

REF.:	COLOR
013740001	Blanco
013750001	Bone

OTROS REPUESTOS



**BISAGRA SANITARIO
ACTIVE BLANCO**

REF.:	PAQUETE
799070001	Und.

COMPLEMENTOS KIT BIDÉ

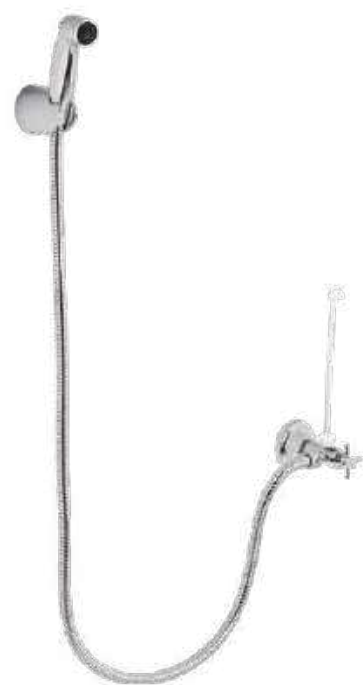

**KIT BIDÉ CON REGULACIÓN
DOBLE METÁLICA**

REF.:	PAQUETE
937330001	Und.
 937335551	Und.



**REGULACIÓN METÁLICA
DOBLE SALIDA**

REF.:	PAQUETE	DIÁMETRO
967310001	Und.	½ pulg.
 967315551	Und.	½ pulg.



**RPTO PISTOLA + SOPORTE
KIT BIDÉ**

REF.:	PAQUETE
039710001	Und.



**GRIFLEX
SANITARIO 40 CM**

REF.:	PAQUETE	DIÁMETRO
380130001	Und.	½ - 7/8 pulg.
 380135551	Und.	½ - 7/8 pulg.
MY 380193331	x12	½ - 7/8 pulg.



**MANGUERA
METÁLICA**

REF.:	PAQUETE
014980001	Und.

GRIVAL

grival.com

**LA PREFERIDA POR LOS
EXPERTOS**